

Application description • 08/2014

# Controlling a SINAMICS G120 Drive through Failsafe S7-300/400F CPU via PROFINET with Failsafe Control of the Safety Functions of the SINAMICS in the TIA Portal

SINAMICS G120 (CU 240E-2 DP-F), SIMATIC S7-300/400F

## Warranty and liability

### Note

The Application Examples are not binding and do not claim to be complete regarding the circuits shown, equipping and any eventuality. The Application Examples do not represent customer-specific solutions. They are only intended to provide support for typical applications. You are responsible for ensuring that the described products are used correctly. These application examples do not relieve you of the responsibility to use safe practices in application, installation, operation and maintenance. When using these Application Examples, you recognize that we cannot be made liable for any damage/claims beyond the liability clause described. We reserve the right to make changes to these Application Examples at any time without prior notice.

If there are any deviations between the recommendations provided in these application examples and other Siemens publications – e.g. Catalogs – the contents of the other documents have priority.

We do not accept any liability for the information contained in this document.

Any claims against us – based on whatever legal reason – resulting from the use of the examples, information, programs, engineering and performance data etc., described in this Application Example shall be excluded. Such an exclusion shall not apply in the case of mandatory liability, e.g. under the German Product Liability Act (“Produkthaftungsgesetz”), in case of intent, gross negligence, or injury of life, body or health, guarantee for the quality of a product, fraudulent concealment of a deficiency or breach of a condition which goes to the root of the contract (“wesentliche Vertragspflichten”). The damages for a breach of a substantial contractual obligation are, however, limited to the foreseeable damage, typical for the type of contract, except in the event of intent or gross negligence or injury to life, body or health. The above provisions do not imply a change of the burden of proof to your detriment.

Any form of duplication or distribution of these Application Examples or excerpts hereof is prohibited without the expressed consent of Siemens Industry Sector.

### Security information

Siemens provides products and solutions with industrial security functions that support the secure operation of plants, solutions, machines, equipment and/or networks. They are important components in a holistic industrial security concept. With this in mind, Siemens' products and solutions undergo continuous development. Siemens recommends strongly that you regularly check for product updates.

For the secure operation of Siemens products and solutions, it is necessary to take suitable preventive action (e.g. cell protection concept) and integrate each component into a holistic, state-of-the-art industrial security concept. Third-party products that may be in use should also be considered. For more information about industrial security, visit <http://www.siemens.com/industrialsecurity>.

To stay informed about product updates as they occur, sign up for a product-specific newsletter. For more information, visit <http://support.automation.siemens.com>.

# Table of contents

<b>Warranty and liability</b> .....	<b>2</b>
<b>1 Task</b> .....	<b>5</b>
<b>2 Solution</b> .....	<b>6</b>
2.1 Overview of the general solution.....	6
2.2 Description of the core functionality .....	7
2.2.1 Configuring the communication.....	7
SINAMICS .....	7
SIMATIC S7-300F/400F.....	7
2.2.2 Data exchange .....	7
Cyclic process data exchange .....	8
Acyclic data exchange (parameter access) .....	8
2.3 Hardware and software components used.....	9
<b>3 Setting up and Commissioning the Application</b> .....	<b>11</b>
3.1 Wiring .....	11
3.2 Setting the PROFI-safe address .....	13
3.3 IP addresses and PN device names .....	13
3.4 Settings on PG/PC .....	14
3.5 Downloading the SIMATIC program .....	15
3.6 Downloading the SINAMICS configuration .....	18
<b>4 Operating the Application</b> .....	<b>21</b>
4.1 Prerequisites .....	21
4.2 Operating the application .....	21
4.2.1 Operating the standard functions .....	21
4.2.2 Operating the safety functions .....	22
4.3 Monitoring and parameter access via operator panel.....	23
4.3.1 Screens and screen navigation.....	23
4.3.2 Process data exchange.....	24
Control and status word .....	24
Setpoint and actual values .....	25
4.3.3 Safety data exchange.....	26
Safety control and status words .....	27
4.3.4 Parameter access .....	28
Reading/writing parameters .....	28
Fault buffer .....	29
<b>5 Functional Mechanisms of this Application</b> .....	<b>31</b>
5.1 Functionality of process data exchange.....	32
5.1.1 Accessing process data in the user program of the controller .....	32
5.1.2 Standardizing the setpoint and actual values .....	32
5.1.3 Transfer methods .....	33
Load/transfer or MOVE .....	33
"DPRD_DAT" / "DPWR_DAT".....	33
"PNIO_SEND" / "PNIO_RECV".....	34
5.1.4 Control and status word .....	35
5.1.5 FB 11 "Process_Data_SFC" .....	37
5.1.6 The FB 13 "Process_Data_LT" and FB 14 "Process_Data_MOVE".....	38
5.1.7 FB 12 "Process_Data_CP".....	39
5.2 Parameter access functionality .....	40
5.2.1 Job and response structure.....	40
5.2.2 The DBs "read/write_drive_parameters" and "answer_from_drive" .....	41

## Table of contents

---

5.2.3	FB 20 "Parameter_Access" .....	43
5.3	Safety functionality .....	46
5.3.1	Configuration/settings.....	46
5.3.2	FB 1 "Main_Safety" .....	46
5.3.3	Safety control and status words .....	47
5.3.4	PROFIsafe addresses .....	48
<b>6</b>	<b>Configuration and Settings.....</b>	<b>50</b>
6.1	Configuring the S7-300/400 controller .....	50
6.2	Configuration of the SINAMICS G120 drive via Ethernet .....	57
6.3	Configuring the SINAMICS G120 drive via USB.....	65
<b>7</b>	<b>Related literature .....</b>	<b>68</b>
<b>8</b>	<b>History.....</b>	<b>68</b>

# 1 Task

The SIMATIC S7 300/400 can be operated as a PROFINET controller. A SINAMICS drive can be used as PROFINET device and be controlled by the failsafe S7-300/400F.

This application example illustrates how to configure the SINAMICS and the S7-300/400F, start it up and access process data and parameters. At the same time, safety-related data can be exchanged between the controller and the drive.

## Overview of the automation task

The following figure gives an overview of the automation task:

Figure 1-1: Overview of the task

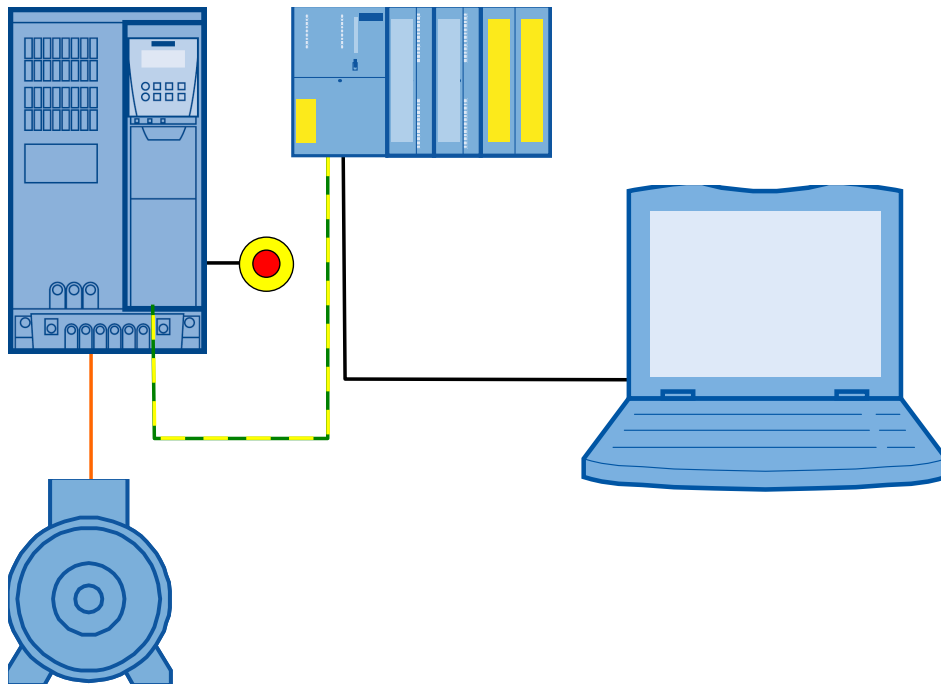

## Requirements for the automation task

Table 1-1: Requirements

Requirement	Explanation
Access to process data	The drive shall be switched on and off via the control word and the speed value is to be specified as quickly as possible.
Access to parameters	Read and write access from the controller to the parameters in the converter (in this example: ramp up and ramp down time) should be possible and be performed using as few resources as possible, i.e. small communication load.
Safety function of the converter	The SINAMICS converters have the option of performing a fail-safe shutdown (e.g. emergency-stop, safe speed, etc.). These functions are safely triggered by the F-CPU.

## 2 Solution

This application example gives an example of how to connect a SINAMICS G120 to a SIMATIC S7-300F using a GSD file in TIA Portal in STEP 7 Professional V13.

### 2.1 Overview of the general solution

#### Schematic layout

The following figure gives a schematic overview of the most important components of the solution:

Figure 2-1: Overview of the general solution

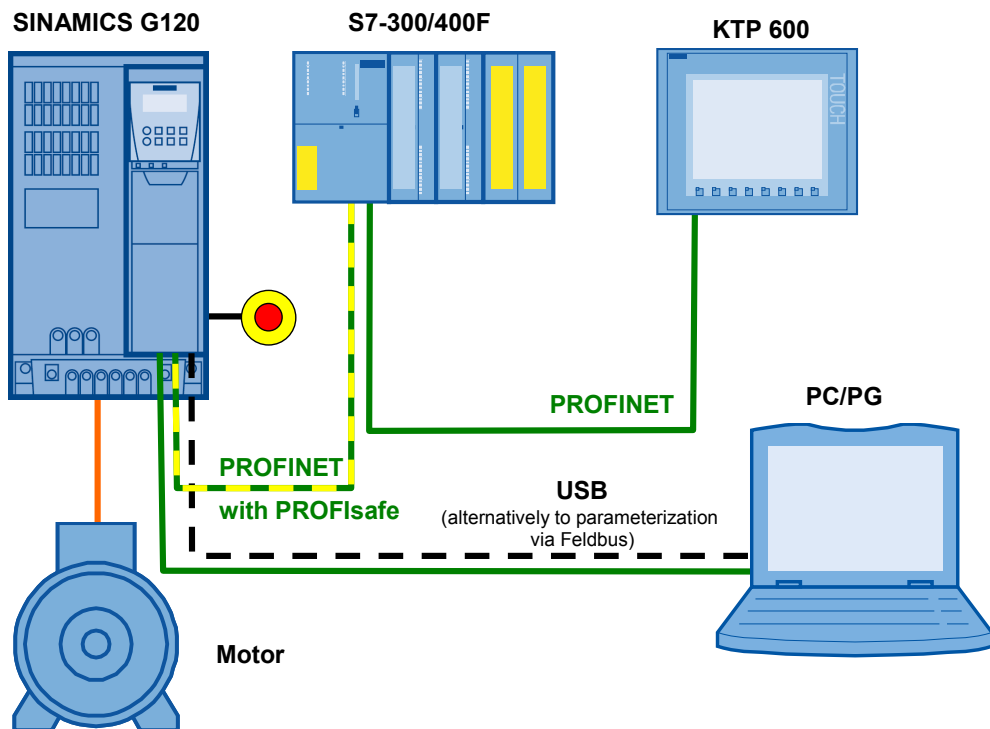

The example shows you how ...

- ...the S7-300/400F controller is configured.
- ...the communication is programmed in the S7-300/400F controller.
- ...the SINAMICS G converter is configured using STARTER.
- ...the standard and extended safety functions of the SINAMICS are triggered by the F-CPU.
- .. the three safety-related inputs of the SINAMICS are used as F-DI in the F-CPU.

## 2.2 Description of the core functionality

### 2.2 Description of the core functionality

#### 2.2.1 Configuring the communication

Controller and converter are programmed with independent software packages. Therefore, the communication data must be entered twice.

#### SINAMICS

The configuration of SINAMICS G120 is performed using the STARTER commissioning tool.

For SINAMICS one of several telegram types can be selected for the data exchange. This defines which data is transmitted or received in which order. It is important that the same telegram type is selected when configuring the controller.

#### SIMATIC S7-300F/400F

In this example SIMATIC S7-300/400F is programmed with STEP 7 Professional V13. For SINAMICS G120 and the telegram type to appear in the hardware catalog in TIA Portal, a device description file (GSDML) must be imported. It is important that the same telegram type is selected as for the configuration of SINAMICS.

When inserting SINAMICS into the SIMATIC project, the I/O addresses which shall be used by the controller for accessing the converter are also specified.

#### 2.2.2 Data exchange

Data exchange between drive and PLC occurs in two areas:

- Process data,  
i.e. control word(s) and setpoint(s), or status word(s) and real value(s)
- Parameter area,  
i.e. reading/writing of parameter values

#### Note

The two areas, process data and parameters, are independent from each other and can also be used individually.

## 2.2 Description of the core functionality

### Cyclic process data exchange

Process data is transferred cyclically, which means in each bus cycle, in order for them to be transferred as quickly as possible.

The S7-300/400F transmits the control word and the setpoint value to SINAMICS and receives the status word and the real value.

Depending on the telegram type, two further setpoint or real values, or extended control or status words can be transferred respectively.

- On the controller side the process data is supplied as I/O input or output words.
- In the drive, the configuration specifies which bits of the control word are used and which data is transmitted to the controller.

The safety-related communication is also transferred cyclically.

- On the controller side the required functions are enabled by selecting an additional PROFIsafe telegram.
- The configuration of the safety functions to be used specifies in the drive whether and which PROFIsafe telegram is expected by the controller.

### Acyclic data exchange (parameter access)

To be able to transfer parameters, telegram types were defined where four words are provided for a parameter (PIV) transfer. Since these four words, like the process data (PZD), are always transmitted, a permanent communication load is produced even though the parameters themselves are generally only rarely transferred.

Apart from the cyclic data exchange there is also the option to use an acyclical data exchange that is only used if required. This makes it possible to transfer the parameter area acyclically on demand, without creating a permanent communication load. The acyclic transfer takes clearly longer than the cyclic transfer of the process data.

In the example the acyclical data exchange is used to access the parameters.

- In the controller, parameter jobs are sent to the drive by writing data record 47, and the response of the drive is read in by reading data record 47.
- No particular action is required on the drive side.

#### Note

When using a CP342-1, the parameters of the drive cannot be accessed and no safety-related communication can be transmitted.



## 2.3 Hardware and software components used

The application document was generated using the following components:

### Hardware components

Table 2-1: Hardware components

Component	Qty.	Order number	Note
CPU 315F-2 DP/PN	1	6ES7315-2FJ14-0AB0	or another S7-300F/400F CPU with PROFINET
MMC 128kB	1	6ES7953-8LG30-0AA0	or larger MMC
SM 323	1	6ES7323-1BH00-0AA0	or another module with DIs
SM 326	1	6ES7326-1BK02-0AB0	or another module with F-DIs
SINAMICS G120	1	6SL3244-0BB13-1FA0 (CU 240E-2 PN-F) and 6SL3224-0BE22-2UA0 (PM240)	or another SINAMICS G120 with CU240x-2 PN -F
SIMATIC Panel KTP600 Basic color PN	1	6AV6647-0AD11-3AX0	This panel is optional.
SINAMICS G120 PC converter connection kit 2m	1	6SL3255-0AA00-2CA0	Includes STARTER on DVD and USB cable. Alternatively, the software can be downloaded and a standard micro USB cable be used as well.
SINAMICS IOP or SINAMICS BOP-2	1	6SL3255-0AA00-4JA1 6SL3255-0AA00-4CA1	optional
PROFINET connector plug	6	6GK1901-1BB10-2AA0	The number is already taken into account for the connection with the PG/PC
PROFINET line		6XV1840-2AH10	
Motor	1	1LA7083-4AA60	

### Standard software components

Table 2-2: Standard software components

Component	Qty.	Order number	Note
SIMATIC STEP 7 Professional V13	1	Floating License 6ES7822-1AA03-0YA5	
STEP 7 SAFETY ADVANCED V13	1	6ES7833-1FA13-0YA5	
STARTER V4.4	1	6SL3072-0AA00-0AG0	Free download: see <a href="#">3</a>
GSDML file for SINAMICS G120	1	-	Free download: see <a href="#">6</a>

## 2.3 Hardware and software components used

### Example files and projects

The following list includes all files and projects used in this example.

Table 2-3: Example files and projects

Component	Note
61450312_SINAMICS_G120_at_S7-300400F-PN_CODE_v11.zip	STEP 7 project.
61450312_SINAMICS_G120_at_S7-300400F-PN_STARTER.zip	STARTER project The password for the safety settings is "12345".
61450312_SINAMICS_G120_at_S7-300400F-PN_DOKU_v11_en.pdf	This document

**CAUTION**

**The STARTER example project is designed for the use with the example components listed in Table 2-1. If a SINAMICS G120 with a different output or a different motor is connected, without adjusting the respective parameters, converter and/or motor can be damaged or destroyed.**

3.1 Wiring

# 3 Setting up and Commissioning the Application

## 3.1 Wiring

The two figures below show the hardware setup of the application:

Figure 3-1: Wiring of the standard signals

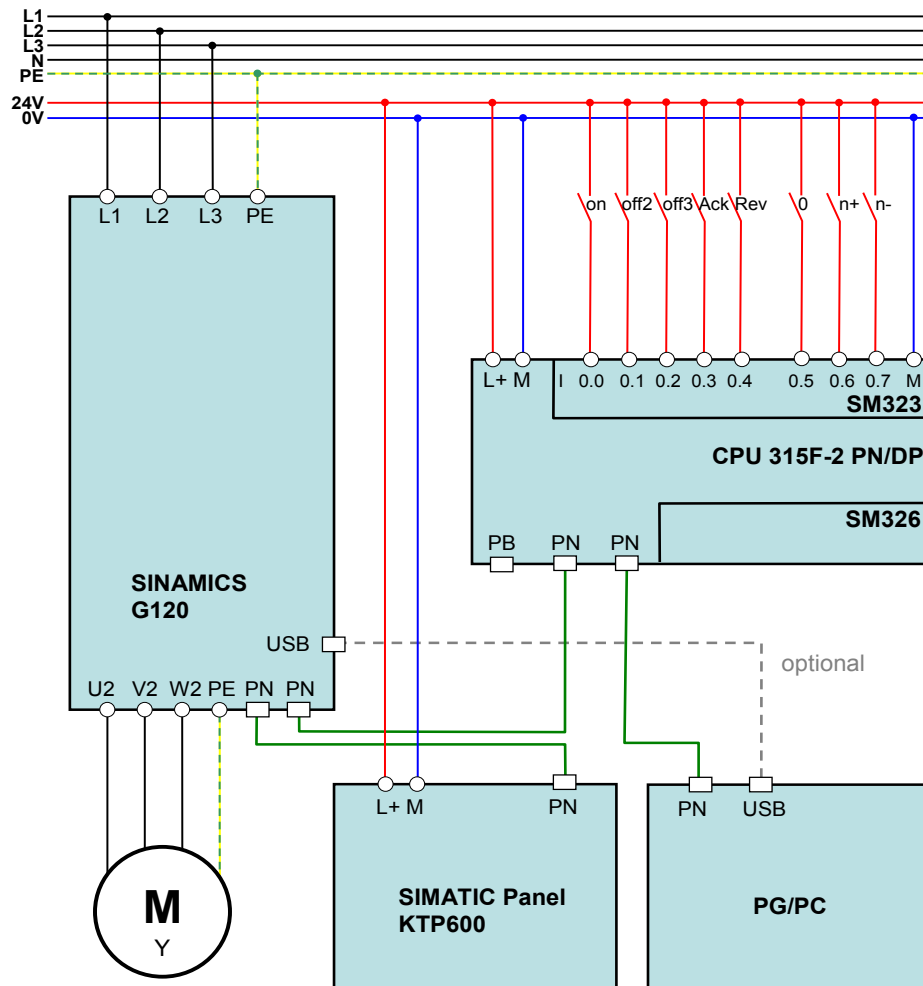

### 3 Setting up and Commissioning the Application

#### 3.1 Wiring

Figure 3-2: Wiring of the safety signals

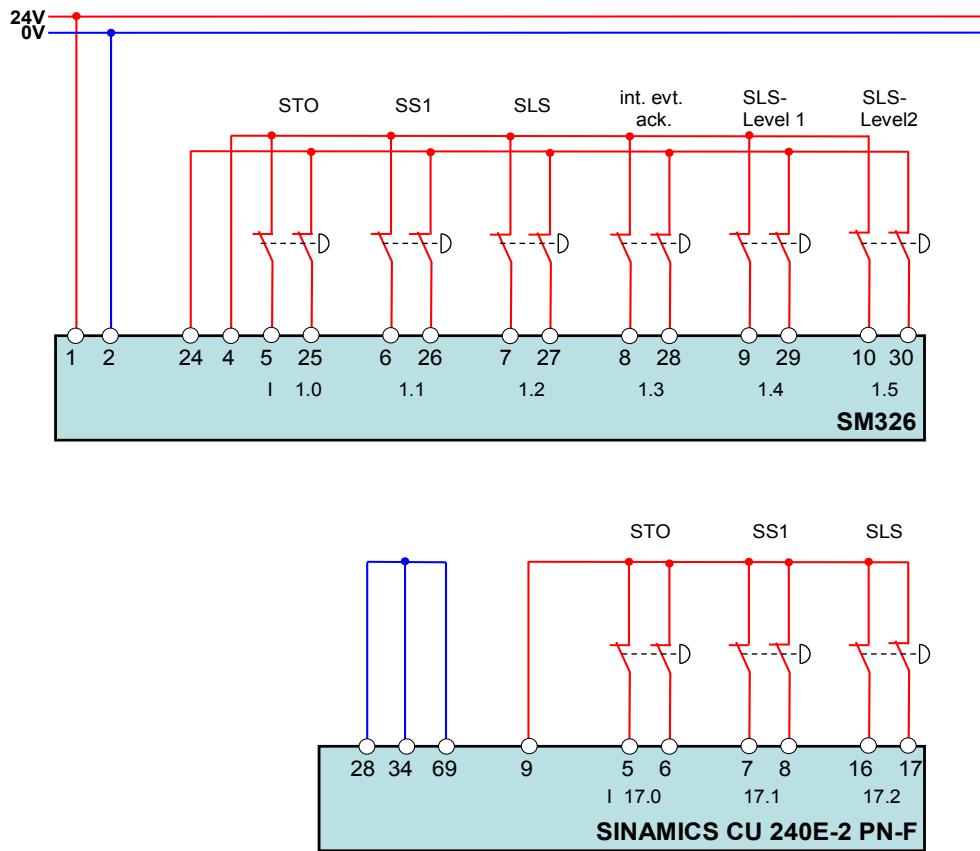

**Note**

The setup guidelines in the SINAMICS G120 manual (see [5](#)) and SIMATIC must generally be followed.

3.2 Setting the PROFIsafe address

### 3.2 Setting the PROFIsafe address

You have to set the PROFIsafe address with the DIP switches on the back of the F-DI module. Enter "000000001" for the example project.

Figure 3-3: Setting the PROFIsafe address

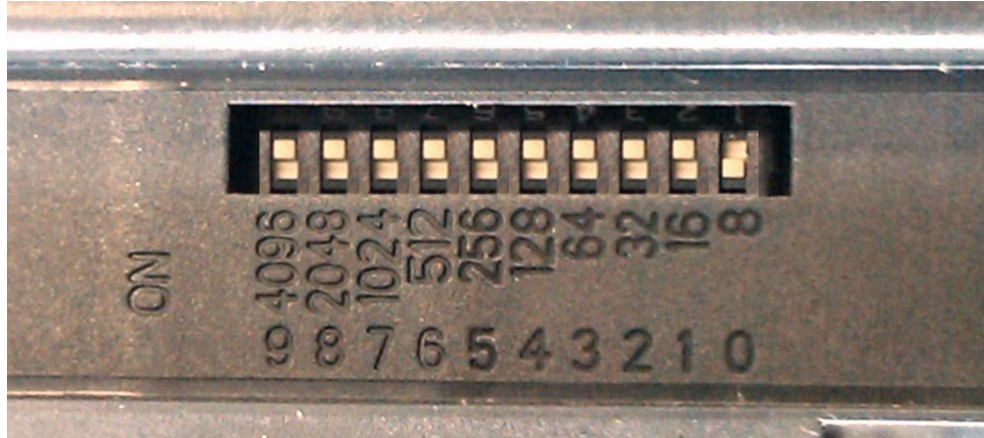

### 3.3 IP addresses and PN device names

In the example the following IP addresses and PROFINET device names are used:

Table 3-1: IP addresses and PN device names



IP	Component	PROFINET device names	Converted name
192.168.0.1	S7-CPU	plc_1	plcxb1d0ed
192.168.0.2	CU240E-2PN -F	sinamics-g120-cu240e-v4.6	sinamics-g120-cu240e-v4.xd609fc
192.168.0.3	KTP600	hmi_1	hmixb110d0
192.168.0.200	PG/PC	-	-

The network mask is always 255.255.255.0 and no router is used.

The PROFINET device name is made up of the (editable) device names the system assigns default and which can be found in the "Properties" of the respective device under "General". However, in the end a converted name according to IEC 61158-6-10 is loaded in the affected device. If the PROFINET device name is already complying with the norm, it is accepted as converted name. More details on naming can be found, e.g. in the information system (online help) of the TIA Portal under "Assigning addresses and names for PROFINET devices".

### 3.4 Settings on PG/PC

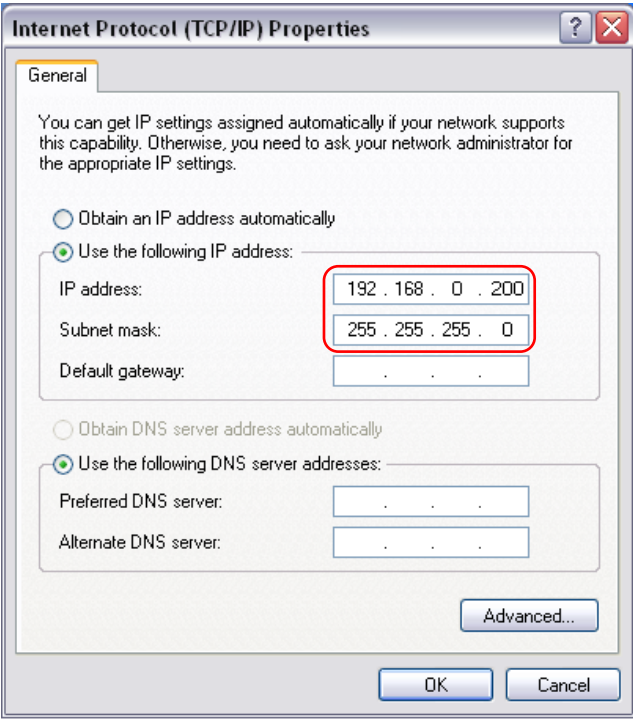
Table 3-2: Instruction – settings on PG/PC

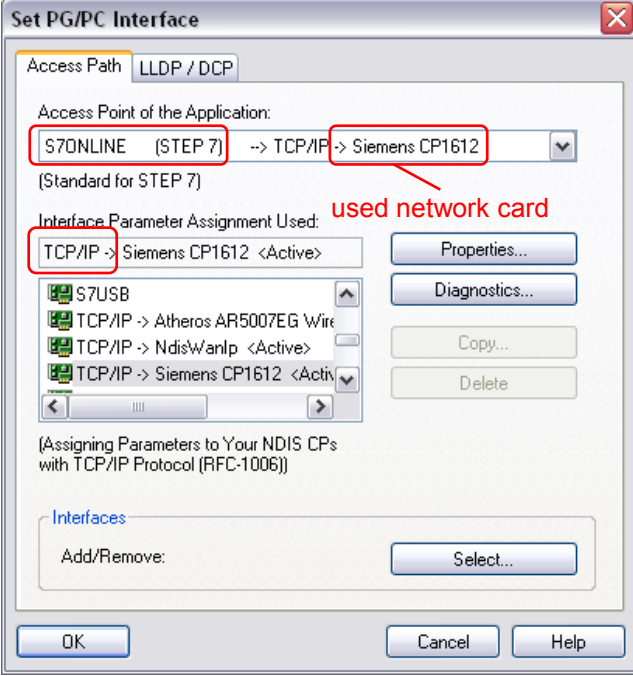
No.	Action	Remarks
1.	<p>Assign a free, fixed IP address 192.168.0.x to the network card used (e.g. x = 200) and assign the subnet mask 255.255.255.0.</p> <p>Navigate in Windows as follows:</p> <ul style="list-style-type: none"> <li>&gt;Start</li> <li>&gt;Settings</li> <li>&gt;Network connections</li> <li>&gt;Right click on network card</li> <li>&gt;Properties</li> <li>&gt;Internet protocol (TCP/IP)</li> <li>&gt;Properties</li> </ul>	
2.	<p>Set the PG/PC interface. Select "S7ONLINE (STEP7)" as access point of the application and "TCP/IP -&gt; network card used" as interface configuration used.</p> <p>Navigate in Windows as follows:</p> <ul style="list-style-type: none"> <li>&gt;Start</li> <li>&gt;System controller</li> <li>&gt; Set PG/PC Interface</li> </ul> 	

3.5 Downloading the SIMATIC program

### 3.5 Downloading the SIMATIC program

This chapter describes the steps for the installation of the example code into SIMATIC.

**Requirements**

- The STEP 7 software according to Table 2-2 is installed on your development system.

Table 3-3: Instruction - downloading the SIMATIC program

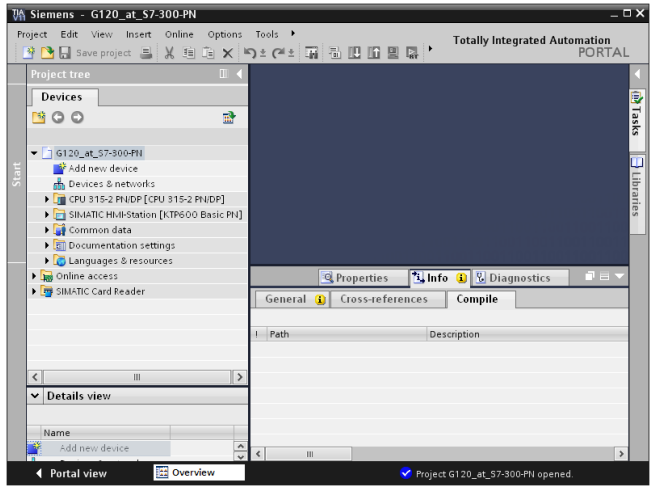
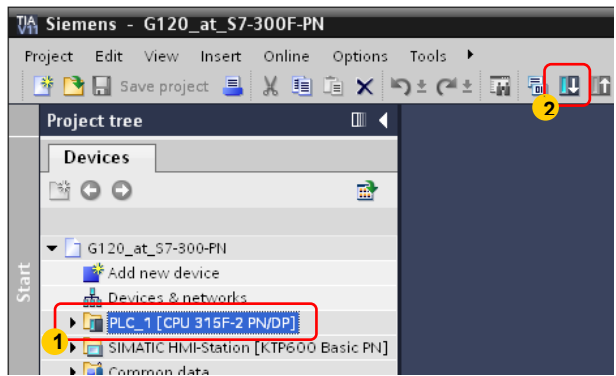
No.	Action	Remarks
1.	Connect the controller with the PG/PC using a network cable.	You can connect both devices directly or via a switch.
2.	Retrieve the project on hand as zip file on Windows level.	
3.	Double click the ap13 file in the project folder just retrieved in order to open the project in TIA Portal.	
4.	Select the controller and initiate the loading process.	

### 3 Setting up and Commissioning the Application

#### 3.5 Downloading the SIMATIC program

No.	Action	Remarks
5.	<p>Select the following interface data in the "Extended download to device" mask:</p> <ul style="list-style-type: none"> <li>Type of PG/PC interface: ⇒ PN/IE</li> <li>PG/PC interface: ⇒ network card used</li> <li>Connection to subnet: ⇒ (local) PN/IE</li> </ul> <p>You may be prompted to tick "Show all accessible devices" in the online status information.</p> <p>Click "Load" as soon as the CPU is reached.</p>	
6.	<p>Make sure that the safety program is loaded consistently (default setting).</p> <p>Exit the "Load preview" mask with the "Load" button.</p>	
7.	<p>Tick "Start all" (modules) (default setting).</p> <p>Exit the "Load results" mask with the "Finish" button.</p>	
8.	<p>To be able to run the KTP600 operator panel as simulation on your PG/PC, select it and start the simulation. Thus, the installation of the example code in the TIA Portal has ended.</p> <p>If you would like to connect a real KTP600 to the controller, continue with steps <a href="#">9</a> to <a href="#">12</a>.</p>	



### 3 Setting up and Commissioning the Application

#### 3.5 Downloading the SIMATIC program

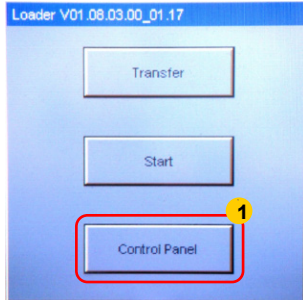
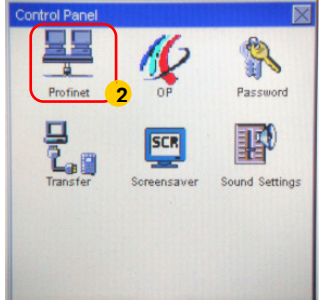
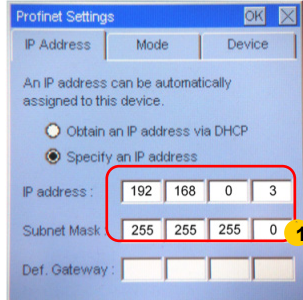
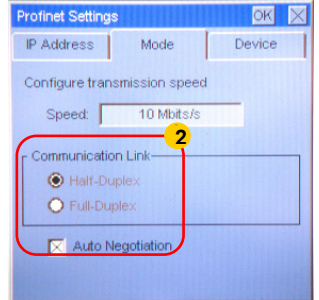
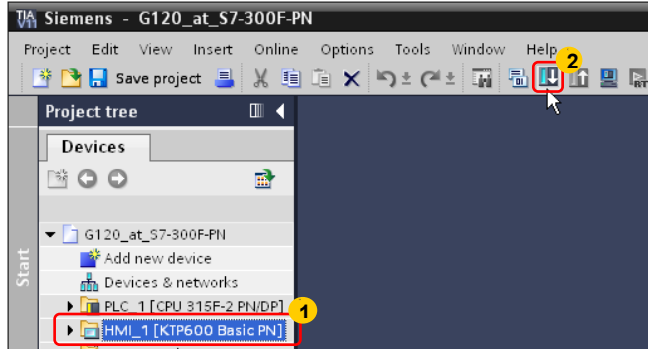
No.	Action	Remarks
9.	Connect the KTP600 to the power supply and open the PROFINET settings in the Control Panel.	 
10.	Make the entries according to the screens on the right. Exit the PROFINET settings with "OK" and close the Control Panel. Subsequently prepare the loading process by clicking the "Transfer" button.	 
11.	Connect the operator panel with an Ethernet patch cable directly to the PG/PC or via a switch and start the data transfer. The operator panel will subsequently start automatically. Now connect the operator panel with the controller (not necessary when using a switch)	
12.	Execute a restart of the controller	<p>Using the stop/start button on the CPU.</p> <p>The restart assigns the IP addresses to the IO devices (drive and operator panel) via the configured and already loaded PROFINET device names.</p> <p>The application is now ready for operation.</p>



### 3.6 Downloading the SINAMICS configuration

This chapter describes the steps for downloading the example configuration. It is assumed that STARTER V4.4 or higher is already installed on your PG/PC.

**Note**

- The download can be performed via USB interface or the field bus interface. Below, the use of the field bus interface is shown.
- Should you use a different inverter or motor you need to perform your own configuration. In that case, follow the instructions in chapter 6 "Configuration and Settings".
- The screenshots below use a general project name: "G120\_at\_S7". In this example, this stands for "G120\_at\_S7-300F-PN"
- The following instruction assumes, that the inverter is in delivery status or reset to factory settings.

Table 3-4: Instruction - downloading the SIMATIC configuration

No.	Action	Remarks
1.	Connect the CU 240E-2 PN-F of SINAMICS G120 with the PG/PC.	
2.	Start the STARTER commissioning software.	

### 3 Setting up and Commissioning the Application

#### 3.6 Downloading the SINAMICS configuration

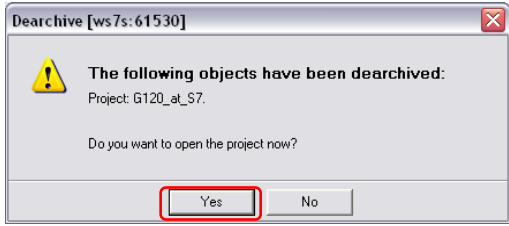
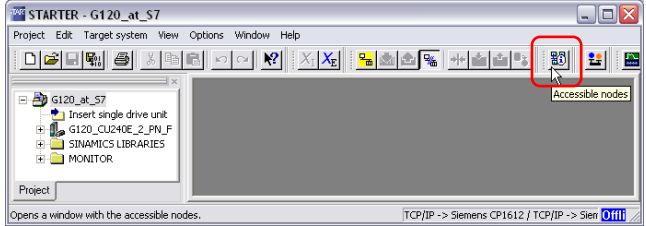
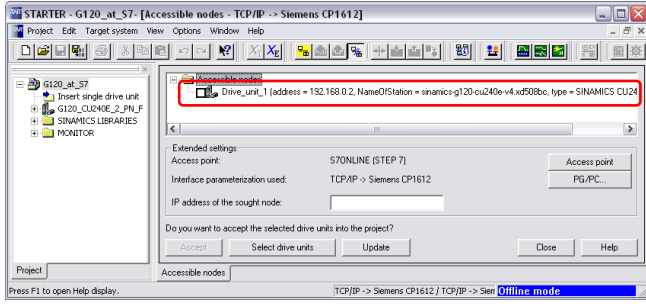
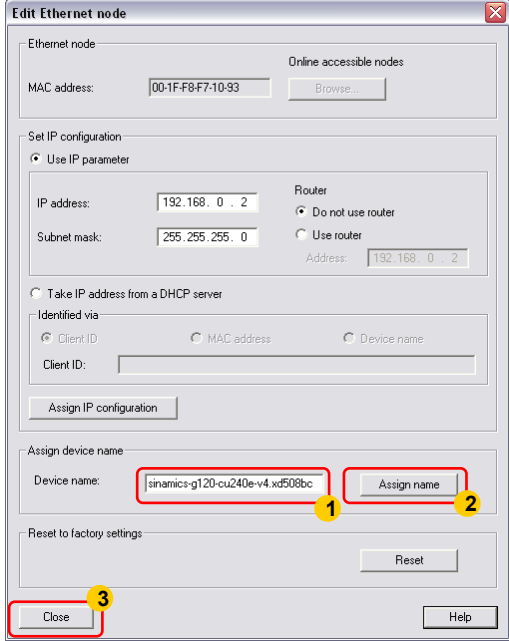
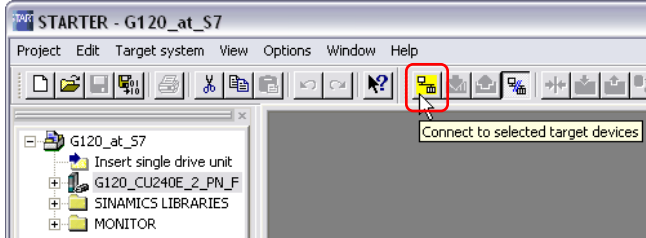
No.	Action	Remarks
3.	Retrieve the STARTER project from Table 2-3 ("File > Retrieve...") and open it.	
4.	Click on "Accessible nodes".	
5.	Right click on the found drive and select "Edit Ethernet node..." from the context menu.	
6.	Assign the PROFINET device name to the IO device (drive) that is used in the network configuration of the CPU.  in the example project: <code>"sinamics-g120-cu240e-v4.xd609fc "</code>	
7.	Select the converter in the tree and go online.	

### 3 Setting up and Commissioning the Application

#### 3.6 Downloading the SINAMICS configuration

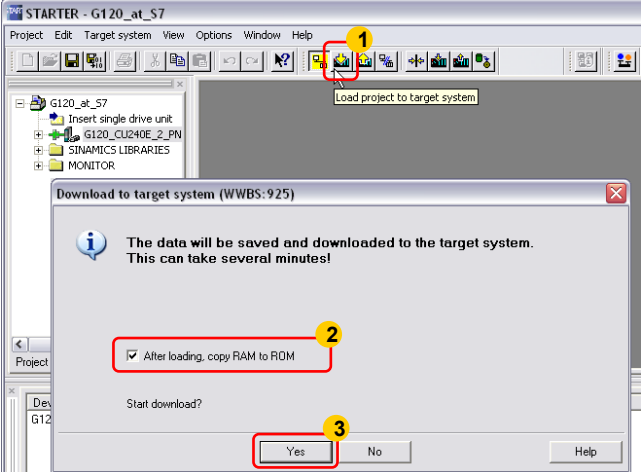
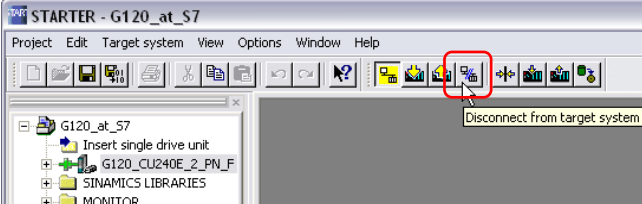



No.	Action	Remarks
8.	Start the download and tick "After loading, copy RAM to ROM".	
9.	Go offline.	
10.	Briefly interrupt the supply voltage of the control unit.	Thus the CU transfers the parameters via a reboot.

4.1 Prerequisites

# 4 Operating the Application

## 4.1 Prerequisites

To be able to switch on the drive via the digital inputs, the following points must be fulfilled:

- If the yellow "SAFE" LED is flashing on the converter, a safety function is active and the drive cannot be switched on (see chap. 4.2.2).
- When using an IOP, please check that the network icon () is displayed on the top right. If the hand icon () is displayed there, press the Hand/Auto button ()
- When using a BOP-2, please check whether the hand icon () is displayed. If yes, press the Hand/Auto button ()

## 4.2 Operating the application

The drive is exclusively moved via digital inputs. The HMI is only used for monitoring.

### 4.2.1 Operating the standard functions

Table 4-1: Standard functions

Terminal	Name	Function
I 0.0	On	Switching the drive on/off, (Off2 and Off3 =1 must apply for the operation)
I 0.1	Off 2	0= Motor immediately switched off, drive spins out
I 0.2	Off 3	0= Fast stop, motor is decelerated with Off3 ramp down time (P1135) until it stops
I 0.3	Ack	Rising edge acknowledges a pending error in the drive
I 0.4	S-Test	Starts the self-test of the extended safety-functions of the SINAMICS G120
I 0.5	0	The setpoint is set to 0.
I 0.6	n+	The setpoint value is increased
I 0.7	n-	The setpoint value is decreased

**4.2 Operating the application**

To switch on the drive, please follow the steps below:

Table 4-2: Instruction – switching on drive

Steps	Action	Note / Result
1.	Apply 24V to Off2 (I0.1) and Off3 (E0.2).	The further required control bits for the operation are permanently set to 1 by the program.
2.	Enter a pulse (switching on and back off) to Ack (I0.3).	This acknowledges a possibly pending error message. The reintegration of passivated safety modules is also performed.
3.	Enter a pulse (switching on and back off) to 0 (I0.5).	The setpoint is set to 0.
4.	Apply 24V to On (I0.0).	The drive switches on.
5.	Change the setpoint value with inputs n+ (I 0.6), n- (I0.7) and 0 (I0.5).	The speed of the motor changes.
6.	Remove the 24V from On (I0.0).	The drive switches back off.

**4.2.2 Operating the safety functions**

The table below shows via which input what function can be triggered in the SINAMICS with the example configuration:

Table 4-3: Safety functions

PLC Terminal	Drive Terminal	Function	Address in the controller
5+25	5+6	STO	I1.0 or I19.0
6+16	7+8	SS1	I1.1 or I19.1
7+27	16+17	PLC	I1.2 or I19.2
8+28		Ack int event.	I1.3
9+29		PLC Level Bit 0	I1.4
10+30		PLC Level Bit 1	I1.5

**Forced dormant error detection**

With input 0.4 the internal test of the shut-down method of the converter can be started. More information regarding this subject can be found in the Safety Integrated functions manual (see [5](#)).

## 4.3 Monitoring and parameter access via operator panel

### 4.3.1 Screens and screen navigation

Figure 4-1: Screen navigation

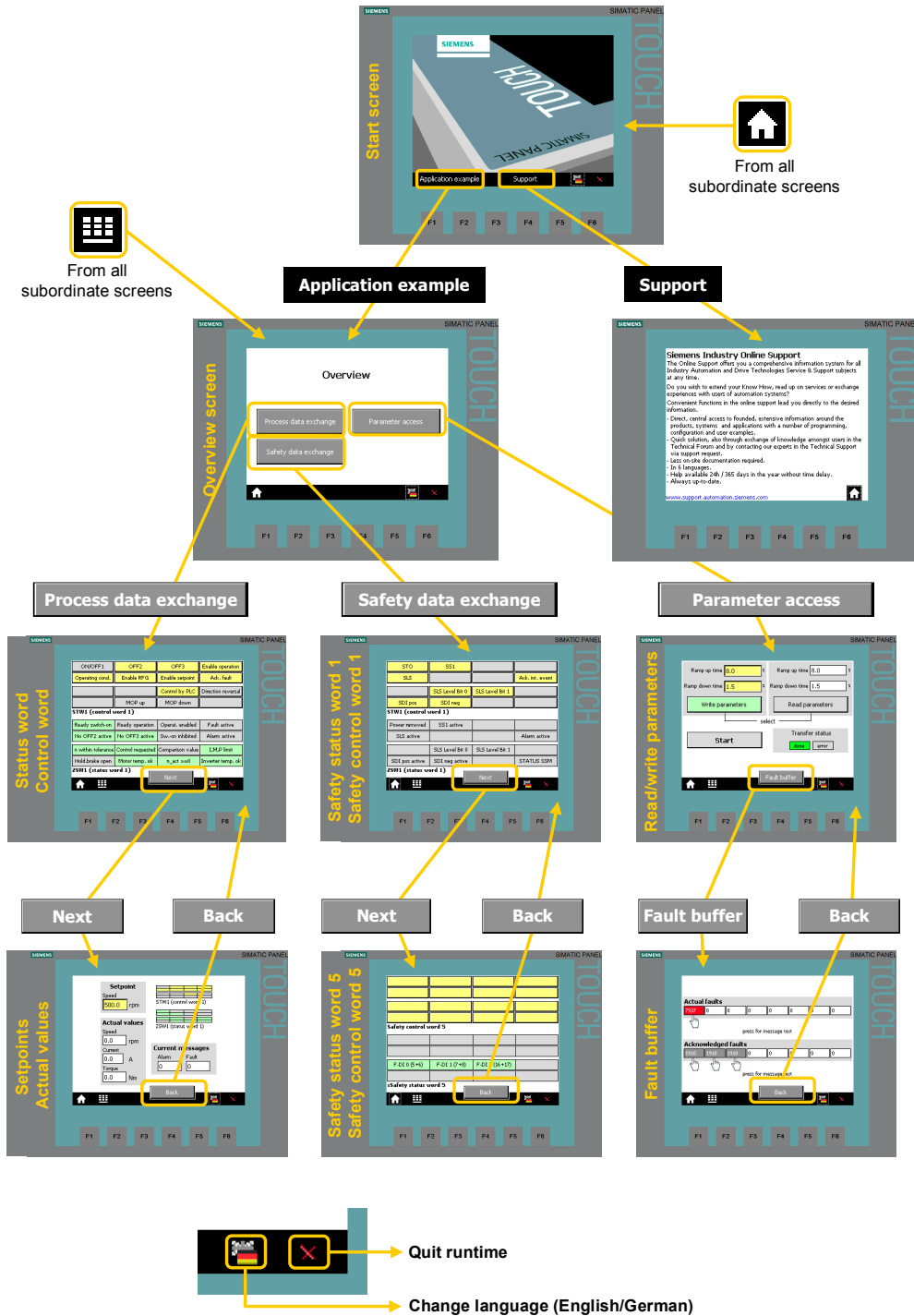

4.3 Monitoring and parameter access via operator panel

4.3.2 Process data exchange

Both screens for the process data exchange access the idb\_Process\_Data\_SFC data block (DB11). The operator panel supports the process data exchange via SFC, which has been realized in this application (see chapter 5.1.3). When selecting a different method, the data block number must be modified accordingly in the tag assignment in WinCC flexible.

Control and status word

Figure 4-2: Control and status word

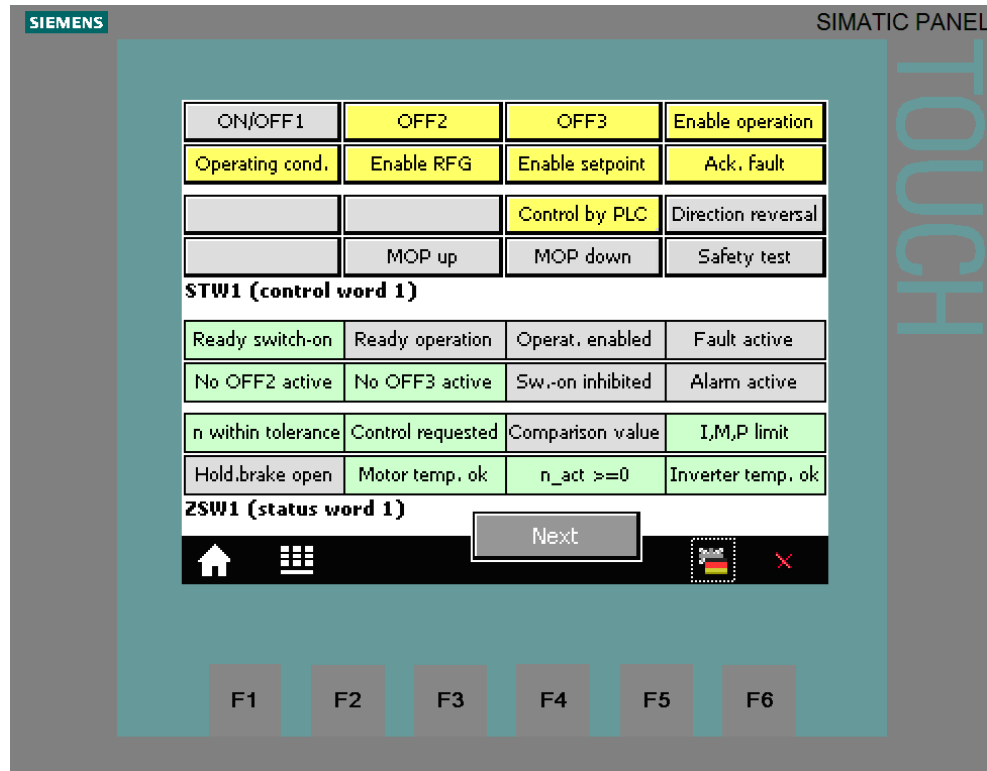

The bit commands, which you can partially specify via the digital input module, are displayed in the 16 bit wide control word.

The current state of the converter is given via the also 16 bit wide status word.

The displayed control or status word is identical with that in the respective Process\_Data\_... tag table.



### Setpoint and actual values

Figure 4-3: Setpoint and actual values

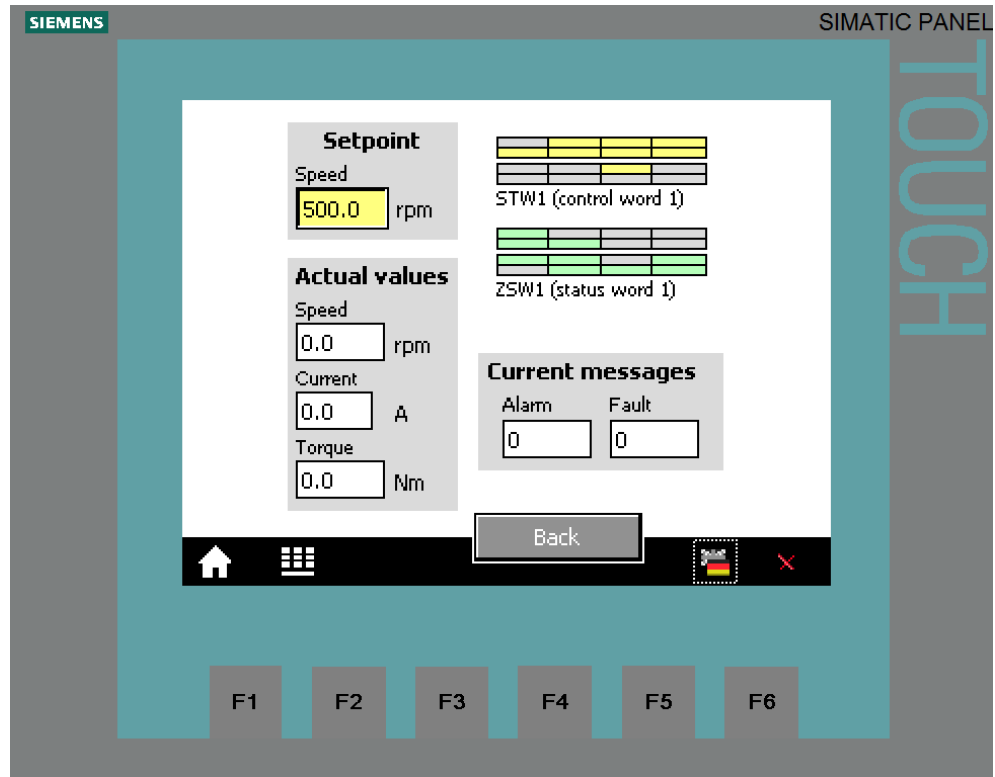

The control tags contained in the above screen are identical with those in the respective Process\_Data\_... tag table.

#### Setpoint speed value:

The yellow field, top left, indicates the setpoint speed value that is set via the digital inputs I0.5 to I0.7 (see Table 4-1) in this example.

#### Actual values:

The current actual values speed, current and torque are displayed below the speed setpoint value input.

#### Control and status word:

To keep an eye on control word and status word, without switching to the respective screen, they are also given here as a miniature display.

#### Current messages:

Current faults and warnings are displayed with a respective number. A "0" means, that no fault or alarm exists. If a message is pending, it is displayed according to Figure 4-4.

## 4 Operating the Application

### 4.3 Monitoring and parameter access via operator panel

Figure 4-4: Current messages as message numbers

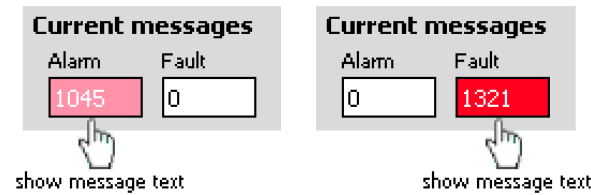

Tap or click on the message number to display the respective message text.

Figure 4-5: Current messages in plain text

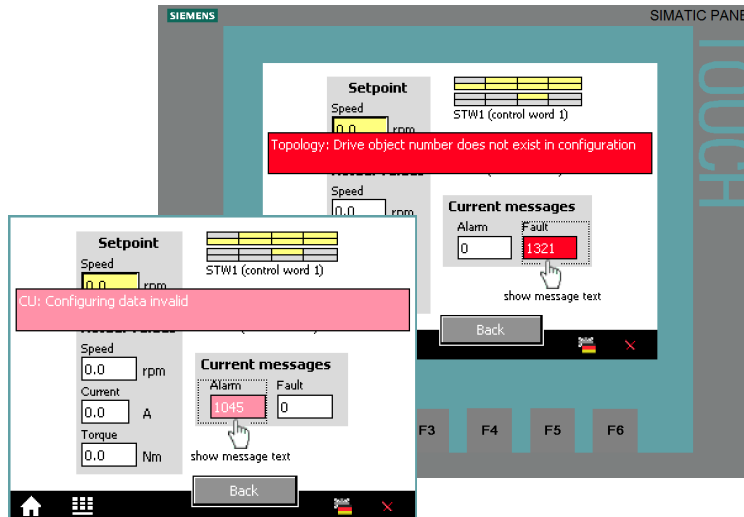

The message text is displayed as long as the message number is pressed.

#### 4.3.3 Safety data exchange

The two figures for the safety data exchange directly access the inputs and outputs.

The bit commands, which you can partially specify via the digital F input module and the F-DIs of the converter (see Figure 4-3), are displayed in the 16 bit wide control word 1.

The safety control word 5 only consists of reserved bytes.

The current state of the safety functions or of the F-DIs of the converter is shown via the safety status words that are also 16 bit wide.

#### Note

Please note that the signal state "1" (depicted in color) signifies the non-active function and the signal state "0" (gray) means the active function.

The bits of the SLS threshold are only shown in the safety status word 1 if the function is active.

The Safety Status/Control words in the following two HMI screens are identical to those in the watch table "Safety".

Safety control and status words

Figure 4-6 Safety control and status word 1

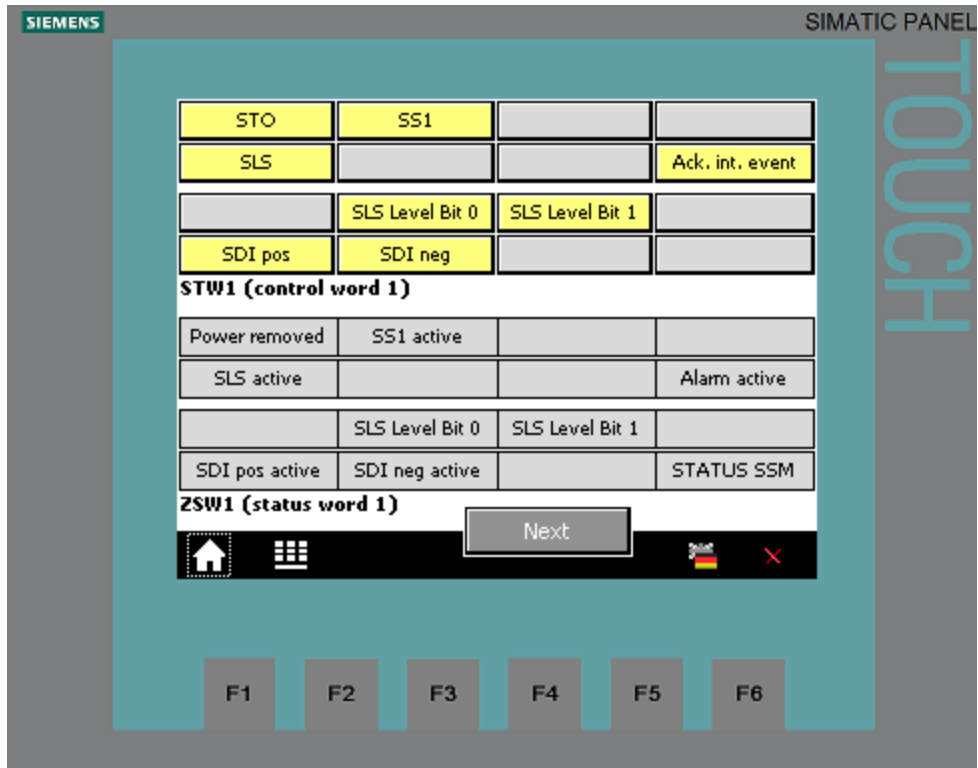
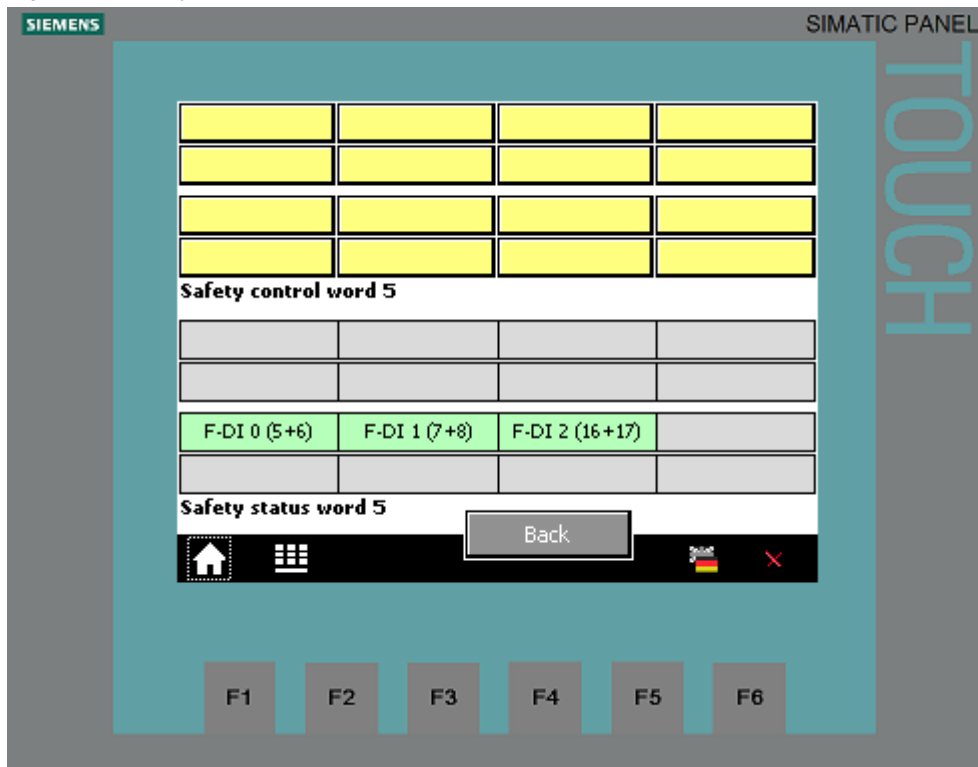

Figure 4-7 Safety control and status word 5



4.3.4 Parameter access

Reading/writing parameters

Figure 4-8: Reading/writing parameters

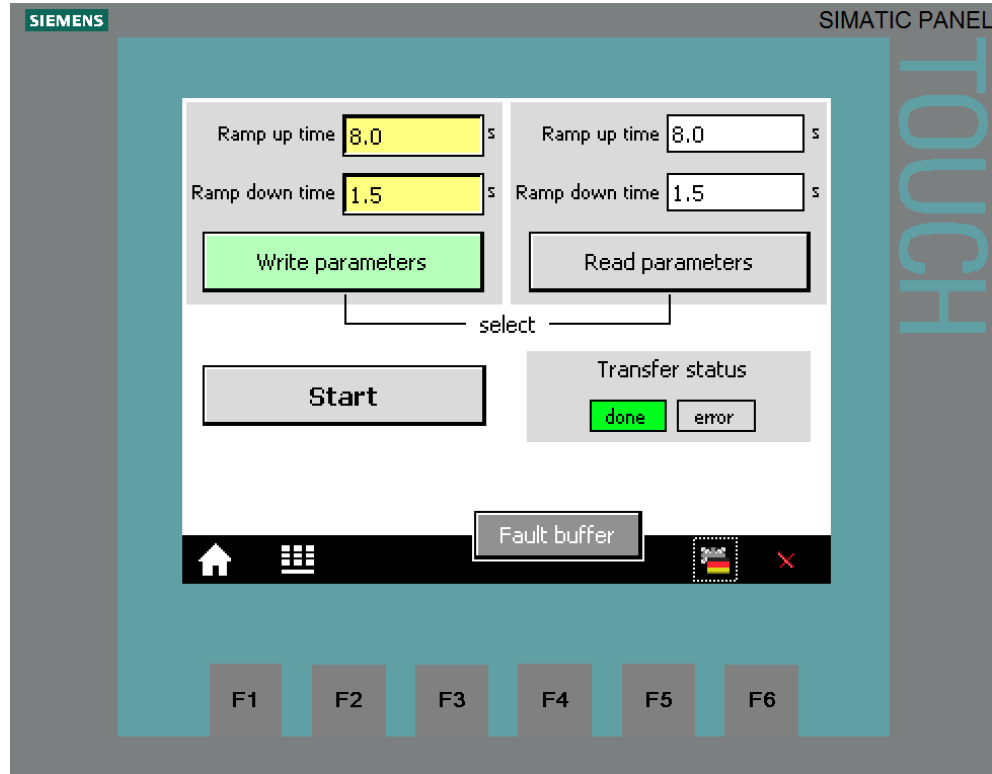

The control tags contained in the above screen are identical with those in the respective Parameter\_access\_... tag table.

Table 4-4: Instructions – writing/reading parameters

	Action	Remark
1.	Select the access type with the "Read parameters" and "Write parameters" buttons.	The selected access type is displayed via a bright green button.
2.	<p><u>Read parameters:</u> Proceed with point 3 in the table.</p> <p><u>Write parameters:</u> When tapping or clicking the yellow input fields for the ramp up/ramp down time, a keyboard mask for the value input opens. Close your input with the Return key.</p>	

**4.3 Monitoring** and parameter access via operator panel

	Action	Remark
3.	Start the write or read job with the "Start" button. <u>Note:</u> After a write job the new data is adopted as read parameters in the white fields in the left part of the screen. After writing you need not trigger any additional read job for the update.	The job status specifies how the job was completed: <span style="background-color: #90EE90;">done</span> = completed without errors <span style="background-color: #FF0000;">error</span> = completed with errors The status relates to the processing of the instructions "RDREC" and "WRREC" in FB20 "Parameter_Access" for the communication to the IO device. For fault diagnostics see <a href="#">/1/</a> .

**Fault buffer**

The screen displays the fault codes of eight current and eight acknowledged faults, which are saved in the converter.

**CAUTION** The fault buffer is read from the drive only together with the parameters. The displayed values are not actualized automatically and show the fault buffer of the moment of the last reading of the parameters.

Figure 4-9: Display of fault buffer

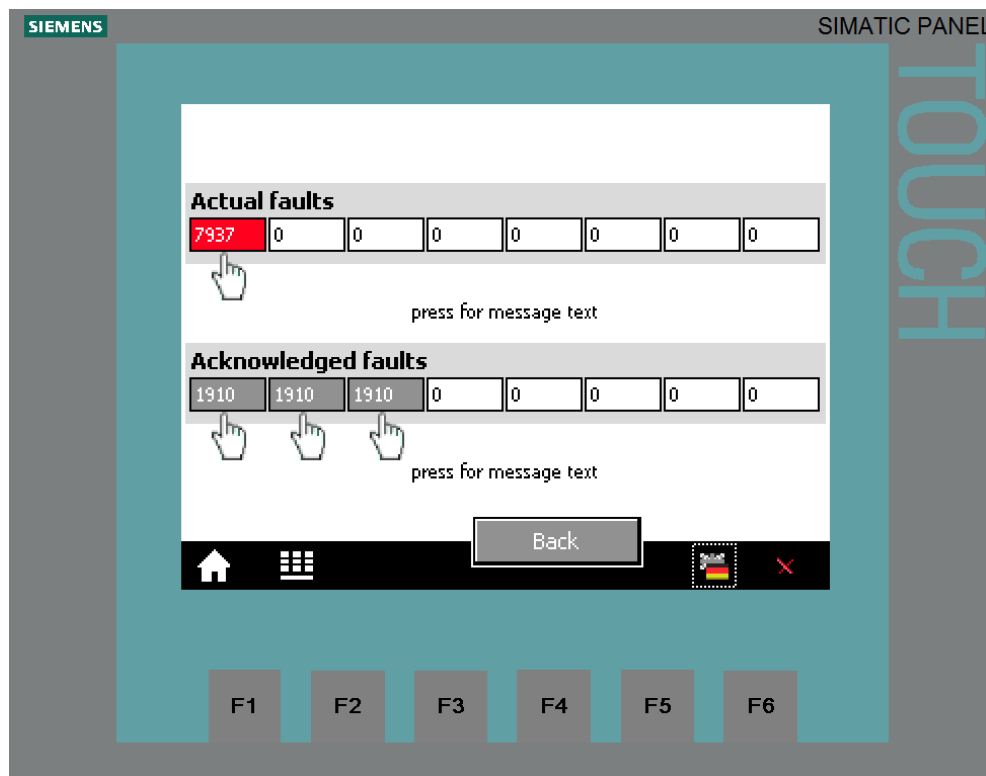

The fault codes in the above screen correspond to the control tags V\_3\_Value\_00 (DW18) to V\_3\_Value\_15 (DW48) in the "answer\_from\_drive" data block (DB103).

## 4 Operating the Application

### 4.3 Monitoring and parameter access via operator panel

Tap or click on the message number to display the respective message text.

Figure 4-10: Display of fault buffer message in plain text

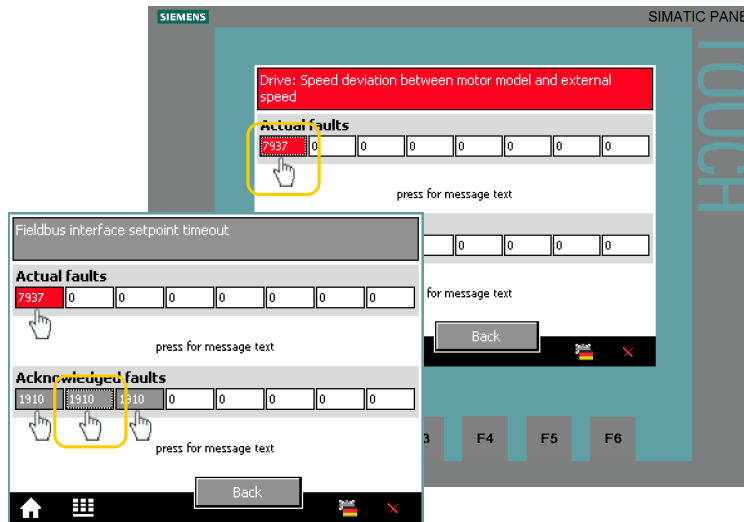

The message text is displayed as long as the message number is pressed.

## 5 Functional Mechanisms of this Application

### Program overview

Figure 5-1: Block structure (overview)

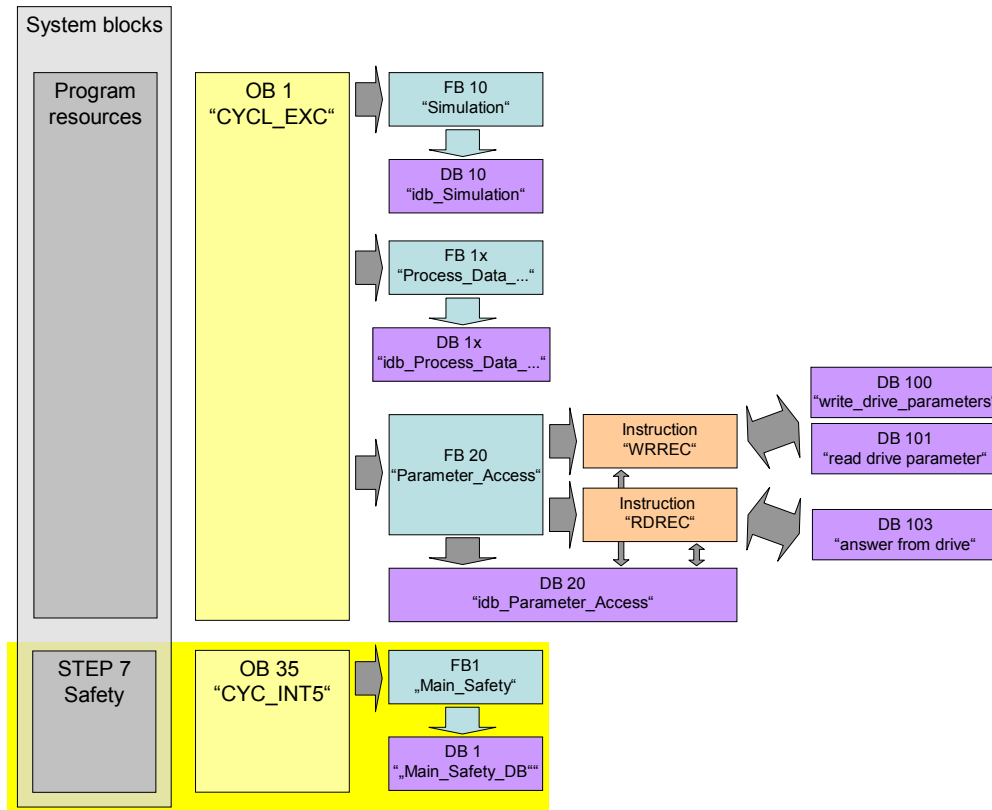

The SIMATIC program consists of four areas:

- **Simulation**  
In this area, the control signals are created for the converter, which are then transmitted as process data to the drive.
- **Process data exchange**  
In this area, the process data for the converter is transmitted (e.g. one command and setpoint) or received (status and actual values)
- **Parameter access**  
In this area, the parameters from the converter are accessed.
- **Safety program**  
In this area the failsafe program is processed.

#### Note

The two communication areas, process data and parameter access, are independent from each other and can each also be used individually.

## 5.1 Functionality of process data exchange

Figure 5-2: Block structure of process data exchange

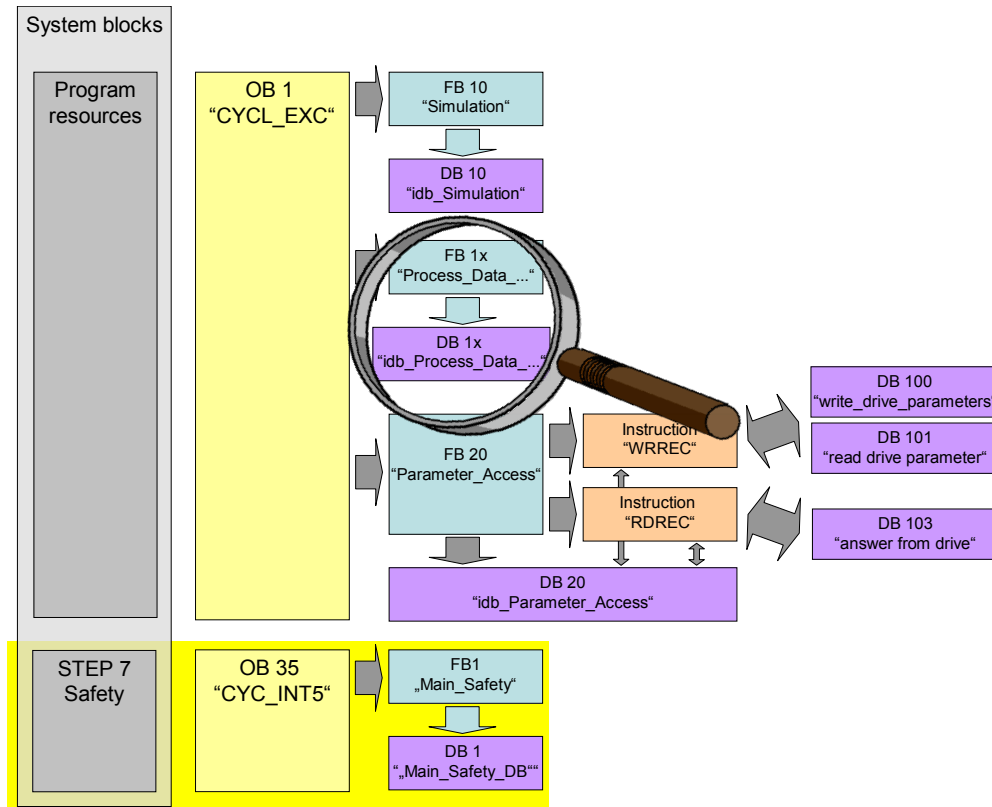

The process data contains values which are regularly exchanged between controller and converter. These values are at least the control and status word as well as the setpoint and actual value. Selecting the telegram type specifies the exact length and structure.

The "Siemens Telegram 352, PZD 6/6" telegram type used in the example exchanges 6 words in both directions.

### 5.1.1 Accessing process data in the user program of the controller

At the start of the cycle, the operating system of S7-300/400 stores the (user) data received by the converter in the I/O input area of the CPU and transmits the data stored in the I/O output area to the converter at the end of the cycle. In the user program, the data can be accessed by copying from or into the I/O area.

The address areas used are defined with the device configuration. See steps 15-16 in Table 6-1.

### 5.1.2 Standardizing the setpoint and actual values

The setpoint and actual values are transferred as standards. The standardization and reference values are stored in parameters P2000 to P2006 of the SINAMICS G120.

16384dez = 4000hex = 100% applies here, with 100% referring to the reference value for the transferred variable.



### 5.1 Functionality of process data exchange

Example:

If P2000 (reference speed or reference frequency) is 1500 1/min and if a speed of 500 1/min shall be run, then 33% or 5461dec must be transferred.

Further information is available in chapter 6 "Configuring the field bus" in the operating instructions ([5](#)) of SINAMICS G120.

#### 5.1.3 Transfer methods

To copy the process data into or from the I/O area, the following methods can be used depending on the requirements:

1. Load and transfer command (STL) or "MOVE" (FBD and LAD)
2. Instructions "DPRD\_DAT" / "DPWR\_DAT"
3. The instructions "PNIO\_SEND" / "PNIO\_RECV" for the use of a CP 343-1

All three methods are contained in the example program. However, in OB1 only the method with "DPRD\_DAT" / "DPWR\_DAT" is called up.

#### Load/transfer or MOVE

The simplest way is using load and transfer commands (STL) or "MOVE" (FBD and LAD). This ensures consistency for each command (1, 2 and 4 bytes) and hence also the consistency within the individual elements, such as control word and setpoint value.

However, the individual elements can origin from different bus cycles or occur in different bus cycles.

However, for the applications for which the SINAMICS G120 is usually used, this is sufficient.

FB 13 "Process\_Data\_LT" in the example program illustrates the use of this method in STL and the FB 14 "Process\_Data\_MOVE" in FBD/LAD.

#### "DPRD\_DAT" / "DPWR\_DAT"

As opposed to the load, transfer or MOVE command, these instructions ensure that the consistency is maintained across the entire process data, i.e. all elements of the process data of a slave are transferred from the same bus cycle or are transferred within a bus cycle. This is necessary, e.g. to enable a distributed synchronization. In the example program, all of the 6 words are copied consistently.

Using "DPRD\_Dat" / "DPWR\_Dat" has no disadvantages, apart from the necessary use of more complex instructions, and a slightly longer processing duration than for the respective load, transfer or MOVE commands which are often avoided by newcomers to programming.

In the "Instructions" task card of the TIA Portal you will find the instructions under

- > Extended Instructions
- > Distributed I/O
- > Others

FB11 "Process\_Data\_SFC" in the example program shows the use of this method.

### 5.1 Functionality of process data exchange

#### "PNIO\_SEND" / "PNIO\_RECV"

When using a CP 343-1, it is mandatory that the process data is transferred with the instructions "PNIO\_SEND" / "PNIO\_RECV". The consistency is provided across the entire process data. In the "Instructions" task card of the TIA Portal you will find the instructions under...

- > Communication
- > Communication processor
- > Simatic NET CP

When compiling the block that contains the instructions, STEP 7 generates the system blocks<sup>1</sup> FC1 ("PNIO\_SEND") and FC0 ("PNIO\_RECV").

FB12 "Process\_Data\_CP" in the example program shows the use of this method.

#### Note

When using a CP 343-1 only the standard process data exchange is possible. The parameter access and the transfer of safety-related signals are **not** possible. For these functions you have to use a local CPU interface for the S7-300.

---

<sup>1</sup> in the project navigation under the CPU in the  
> Program blocks > System blocks > Program Resources folder

## 5.1 Functionality of process data exchange

## 5.1.4 Control and status word

The control and status word has already been defined. The subsequent figures illustrate the control and status word when selecting the "SIEMENS Telegram 352, PZD -6/6" telegram type.

Figure 5-3: Control word of the "SIEMENS telegram 352, PZD -6/6" telegram type

Bit	Value	Significance	Comments
0	0	OFF1	Motor brakes with the ramp-down time p1121 at standstill ( $f < f_{min}$ ) the motor is switched off.
	1	ON	With a positive edge, the inverter goes into the "ready" state, with additionally bit 3 = 1, the inverter switches on the motor.
1	0	OFF2	Switch off motor immediately, motor coasts to a standstill.
	1	No OFF2	---
2	0	Quick stop (OFF3)	Quick stop: Motor brakes with the OFF3 ramp-down time p1135 down to standstill.
	1	No quick stop (OFF3)	---
3	0	Disable operation	Immediately switch-off motor (cancel pulses).
	1	Enable operation	Switch-on motor (pulses can be enabled).
4	0	Lock ramp-function generator	The ramp-function generator output is set to 0 (quickest possible deceleration).
	1	Operating condition	Ramp-function generator can be enabled
5	0	Stop ramp-function generator	The output of the ramp-function generator is "frozen".
	1	Ramp-function generator enable	
6	0	Inhibit setpoint	Motor brakes with the ramp-down time p1121.
	1	Enable setpoint	Motor accelerates with the ramp-up time p1120 to the setpoint.
7	1	Acknowledging faults	Fault is acknowledged with a positive edge. If the ON command is still active, the inverter switches to "closing lockout" state.
8		Not used	
9		Not used	
10	0	PLC has no master control	Process data invalid, "sign of life" expected.
	1	Master control by PLC	Control via fieldbus, process data valid.
11	1	Direction reversal	Setpoint is inverted in the inverter.
12		Not used	
13	1	MOP up	The setpoint stored in the motorized potentiometer is increased.
14	1	MOP down	The setpoint stored in the motorized potentiometer is decreased.
15	1	Start forced checking procedure	Starts the forced checking procedure of the inverter's safety functions

**Note**

A control word for which all bits are 0 is rejected as invalid by the converter. Therefore, at least bit 10 must always be set.

Normally, bit 15 is not assigned in telegram 352. However, in this example the signal for starting the safety function check was assigned to this bit.

## 5 Functional Mechanisms of this Application

### 5.1 Functionality of process data exchange

Figure 5-4 Status word of the "Siemens Telegram 352, PZD 6/6" telegram type

Bit	Value	Significance	Comments
0	1	Ready for switching on	Power supply switched on; electronics initialized; pulses locked.
1	1	Ready for operation	Motor is switched on (ON1 command present), no active fault, motor can start as soon as "enable operation" command is issued. See control word 1, bit 0.
2	1	Operation enabled	Motor follows setpoint. See control word 1, bit 3.
3	1	Fault present	The inverter has a fault.
4	1	OFF2 inactive	Coast to standstill not activated (no OFF2)
5	1	OFF3 inactive	No fast stop active
6	1	Closing lockout active	The motor is only switched on after a further ON1 command
7	1	Alarm active	Motor remains switched on; acknowledgement is not required; see r2110.
8	1	Speed deviation within tolerance range	Setpoint/actual value deviation within tolerance range.
9	1	Control requested	The automation system is requested to assume control.
10	1	Comparison speed reached or exceeded	Speed is greater than or equal to the corresponding maximum speed.
11	0	I, M or P limit reached	Comparison value for current, torque or power has been reached or exceeded.
12	1	Holding brake open	Signal to open and close a motor holding brake.
13	0	Alarm motor overtemperature	--
14	1	Motor rotates forwards	Internal inverter actual value > 0
	0	Motor rotates backwards	Internal inverter actual value < 0
15	1	No alarm, thermal power unit overload	

5.1 Functionality of process data exchange

5.1.5 FB 11 "Process\_Data\_SFC"

This FB shows the access to the process data with the use of the "DPRD\_DAT" / "DPWR\_DAT" instructions. It is called up cyclically in OB1.

Figure 5-5: FB 11 "Process\_Data\_SFC"

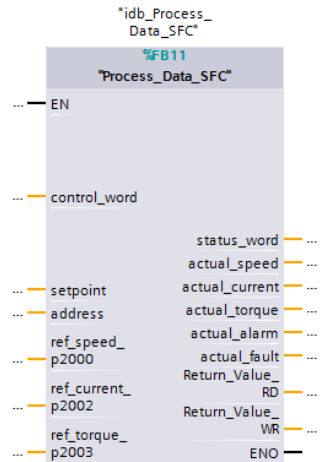

Table 5-1: Networks of FB 11 "Process Data\_SFC"

Network	Function
1.	Initialize the temp area #InData
2.	
3.	The IO address of the drive (INT) is copied to a temporary WORD tag in order to adjust the data type.
4.	The process data is copied from the I/O area into the temporary #InData data area using the "DPRD_Dat" instruction.
5.	Status word, warning and faults are copied from the temporary #InData data area to the respective block outputs, and the current actual values (WORD) are copied into temporary tags (INT) for data type adjustment.
6.	
7.	The current speed is converted into REAL format by calling FC10.
8.	The current electrical current is converted into REAL format by calling FC10.
9.	The current torque is converted into REAL format by calling FC10.
10.	The setpoint (REAL) is converted into the standardized WORD format by calling FC11.
11.	Control word and setpoint (WORD) are copied to the temporary #OUTData data area. 0 is written to the remaining 4 words.
12.	
13.	The process data is copied from the temporary #OutData data area into the I/O area using SFC 15 "DPWR_Dat".

5.1 Functionality of process data exchange

5.1.6 The FB 13 "Process\_Data\_LT" and FB 14 "Process\_Data\_MOVE"

These FBs illustrate the access to the process data with load/transfer commands (STL) or MOVE commands (FBD/LAD). They are not called in the program example, since FB 11 "Process\_Data\_SFC" with the same function is used there.

Figure 5-6 FB: 13 "Process Data\_LT" or FB 14 "Process Data\_MOVE"

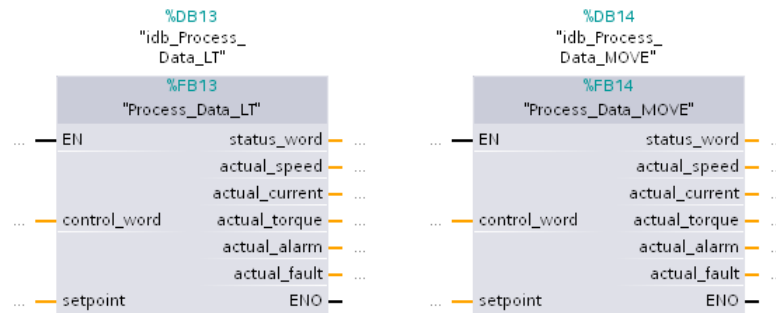

Table 5-2: Networks of FB 13 "Process Data\_LT"

Network	Function
1.	Status word, warning and faults are copied from the #InData I/O area to the respective block outputs, and the current actual values (WORD) are copied into temporary tags (INT) for data type adjustment.
2.	The current actual values are converted into REAL format by calling FC 10.
3.	Control word and setpoint are (after conversion to the standardized WORD format by FC 11) copied to the I/O area.

Table 5-3: Networks of FB 14 "Process\_Data\_MOVE"

Network	Function
1.	Status word, warning and faults are copied from the I/O area to the respective block outputs, and the current actual values (WORD) are copied into temporary tags (INT) for data type adjustment.
2.	
3.	The current speed is converted into REAL format by calling FC10.
4.	The current electrical current is converted into REAL format by calling FC10.
5.	The current torque is converted into REAL format by calling FC10.
6.	Control word and setpoint are (after conversion to the standardized WORD format by FC11) copied to the I/O area.

5.1 Functionality of process data exchange

5.1.7 FB 12 "Process\_Data\_CP"

This FB shows the access to the process data when using a CP343-1. It is not called in the program example, since the device configuration used in the example does not contain a CP343-1.

PNIO devices that are addressed via a CP343-1 require the use of this method.

Figure 5-7: FB 12 "Process\_Data\_CP"

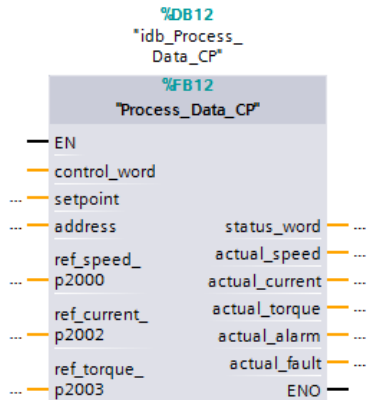
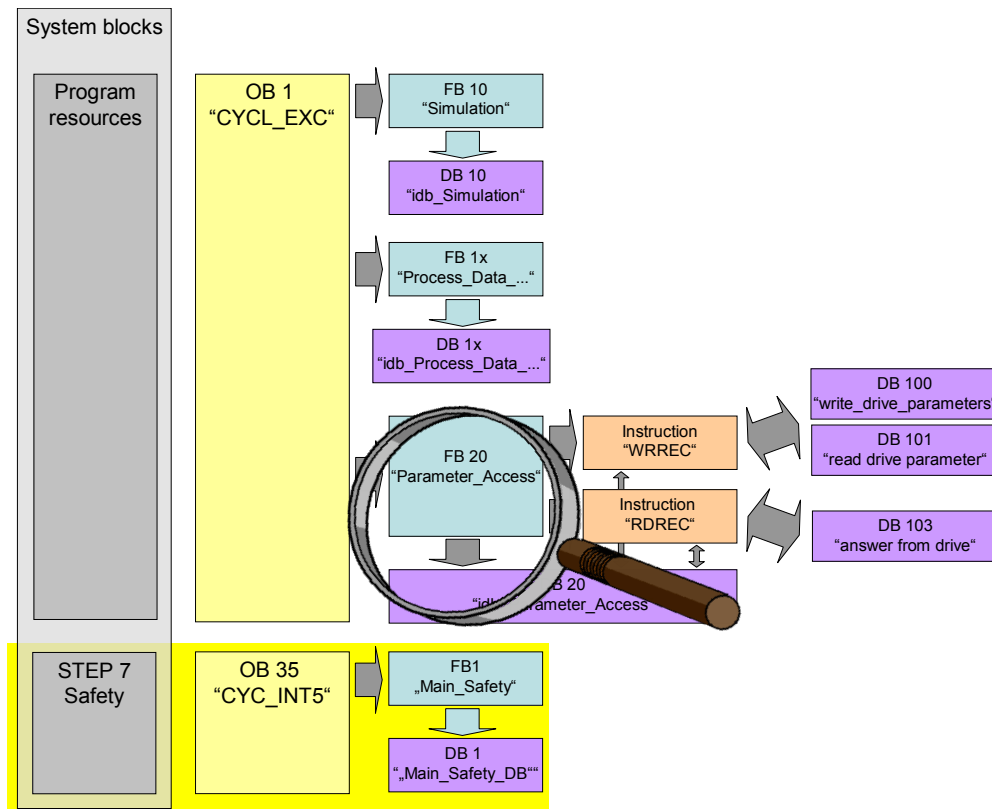

Table 5-4: Networks of FB 12 "Process\_Data\_CP"

Network	Function
1.	Initialize the temp area #InData
2.	
3.	The IO address of the drive (INT) is copied to a temporary WORD tag in order to adjust the data type.
4.	The process data is copied from the I/O area into the temporary #InData data area using FC 2 "PNIO_RECV".
5.	<ul style="list-style-type: none"> <li>Status word, warning and fault are copied from the #InData temporary data area to the respective block outputs.</li> <li>The current actual values (WORD) are copied into temporary tags (INT) for data type adjustment.</li> </ul>
6.	
7.	The current speed is converted into REAL format by calling FC10.
8.	The current electrical current is converted into REAL format by calling FC10.
9.	The current torque is converted into REAL format by calling FC10.
10.	The setpoint (REAL) is converted into the standardized WORD format by calling FC11.
11.	Control word and setpoint (WORD) are copied to the temporary #OutData data area, and 0 is written to the remaining 4 words.
12.	
13.	The process data is copied from the temporary #OutData data area into the I/O area using FC 1 "PNIO_SEND".

## 5.2 Parameter access functionality

Figure 5-8: Block structure of parameter access



Acyclic parameter access occurs parallel to the cyclic process data exchange. This saves resources, since the connection is only established on demand, i.e. when a parameter is to be accessed.

In the controller, the "Write data record" and "Read data record" functions must be used for this. Data record 47 must always be used.

Writing data record 47 sends a job to the converter which performs the job and provides a response. Reading data record 47 makes the response of the converter available in the controller so it can be evaluated.

The instructions "WRREC" and SFB 52 "RDREC" are used in the controller for reading and writing data records.

**Note** Since "WRREC" and "RDREC" cannot be used with CP343-1, accessing the parameters when using the CP is not possible.

### 5.2.1 Job and response structure

The structure of the jobs and responses can be found in [Chapter 7.3.2.1 "Configuring the fieldbus, PROFIdrive profile for PROFIBUS and PROFINET, acyclic communication"](#) in the manual ([5](#)).



5.2 Parameter access functionality

**Note** Since the structure of the data record to be sent or received depends on the number of jobs and their number format, a generally valid structure cannot be used.

5.2.2 The DBs "read/write\_drive\_parameters" and "answer\_from\_drive"

The job to access a parameter consists of at least 10 words. Therefore, the job should be assembled in a DB or in the memory area. In this example, this is performed using DB 101 "read\_drive\_parameters" and DB 100 "Write Drive Parameter".

The response by the converter also consists of several words. Therefore, the example uses DB 103 "answer\_from\_drive".

A job may contain the access to several parameters. Since the length of the data to be transferred per job depends on the number and data types of the converter parameters, no generally valid structure can be devised.

Therefore, in this example, only the ramp up and ramp down times (P1120 and P1121) and a part of the fault memory (P945.x) is accessed. The job to read the parameters is stored in DB 101 "read\_drive\_parameters". The job to write them is stored in DB 100 "write\_drive\_parameters".

The response of the converter is copied to DB 103 "answer\_from\_drive". The structure contained therein corresponds to the structure for a successful reading of the parameters.

Figure 5-9: DB 100 for writing the ramp up and ramp down times

	Name	Data type	Offset	Start value	Retain	Visible in ...	Comment
1	Static						
2	H_Reference	B...	0.0	0	<input checked="" type="checkbox"/>	<input checked="" type="checkbox"/>	HEAD: Reference number
3	H_Request_ID	Byte	1.0	B#16#2	<input checked="" type="checkbox"/>	<input checked="" type="checkbox"/>	HEAD: Request ID: 1=read, 2=write
4	H_Axis	Byte	2.0	B#16#1	<input checked="" type="checkbox"/>	<input checked="" type="checkbox"/>	HEAD: Always 1 for SINAMICS G120
5	H_Number_of_parameters	Byte	3.0	B#16#2	<input checked="" type="checkbox"/>	<input checked="" type="checkbox"/>	HEAD: Number of parameters to transfer
6	A_1_Attribute	Byte	4.0	B#16#10	<input checked="" type="checkbox"/>	<input checked="" type="checkbox"/>	Address: 16#10= parameter value
7	A_1_Number_of_indices	Byte	5.0	0	<input checked="" type="checkbox"/>	<input checked="" type="checkbox"/>	Address: Number of elements (0 to 234)
8	A_1_Parameter_number	Int	6.0	1120	<input checked="" type="checkbox"/>	<input checked="" type="checkbox"/>	Address: Parameter number
9	A_1_Index	Int	8.0	0	<input checked="" type="checkbox"/>	<input checked="" type="checkbox"/>	Address: Index number
10	A_2_Attribute	Byte	10.0	B#16#10	<input checked="" type="checkbox"/>	<input checked="" type="checkbox"/>	Address: 16#10= parameter value
11	A_2_Number_of_indices	Byte	11.0	0	<input checked="" type="checkbox"/>	<input checked="" type="checkbox"/>	Address: Number of elements (0 to 234)
12	A_2_Parameter_number	Int	12.0	1121	<input checked="" type="checkbox"/>	<input checked="" type="checkbox"/>	Address: Parameter number
13	A_2_Index	Int	14.0	0	<input checked="" type="checkbox"/>	<input checked="" type="checkbox"/>	Address: Index number
14	V_1_Format	Byte	16.0	B#16#8	<input checked="" type="checkbox"/>	<input checked="" type="checkbox"/>	Value: Number of index values if parameter value
15	V_1_Number_of_index_valu	Byte	17.0	B#16#1	<input checked="" type="checkbox"/>	<input checked="" type="checkbox"/>	Value: Number of index values
16	V_1_Value	Real	18.0	1.000000e+001	<input checked="" type="checkbox"/>	<input checked="" type="checkbox"/>	Value: Parameter value
17	V_2_Format	Byte	22.0	B#16#8	<input checked="" type="checkbox"/>	<input checked="" type="checkbox"/>	Value: Number of index values if parameter value
18	V_2_Number_of_index_valu	Byte	23.0	B#16#1	<input checked="" type="checkbox"/>	<input checked="" type="checkbox"/>	Value: Number of index values
19	V_2_Value	Real	24.0	1.500000e+001	<input checked="" type="checkbox"/>	<input checked="" type="checkbox"/>	Value: Parameter value

## 5 Functional Mechanisms of this Application

### 5.2 Parameter access functionality

Figure 5-10: DB 101 for reading the ramp up and ramp down time and 16 values of the fault memory

G120\_at\_S7-300F-PN > PLC\_1 [CPU 315F-2 PN/DP] > Program blocks > read\_drive\_parameters [DB101]

read_drive_parameters							
	Name	Data type	Offset	Start value	Retain	Visible in ...	Comment
1	Static						
2	H_Reference	B...	0.0	0	<input checked="" type="checkbox"/>	<input checked="" type="checkbox"/>	HEAD: Reference number
3	H_Request_ID	Byte	1.0	B#16#1	<input checked="" type="checkbox"/>	<input checked="" type="checkbox"/>	HEAD: Request ID: 1=read, 2=write
4	H_Axis	Byte	2.0	B#16#1	<input checked="" type="checkbox"/>	<input checked="" type="checkbox"/>	HEAD: Always 1 for SINAMICS G120
5	H_Number_of_parameters	Byte	3.0	B#16#3	<input checked="" type="checkbox"/>	<input checked="" type="checkbox"/>	HEAD: Number of parameters to transfer
6	A_1_Attribute	Byte	4.0	B#16#10	<input checked="" type="checkbox"/>	<input checked="" type="checkbox"/>	Address: 16#10= parameter value
7	A_1_Number_of_indices	Byte	5.0	0	<input checked="" type="checkbox"/>	<input checked="" type="checkbox"/>	Address: Number od elements (0 to 234)
8	A_1_Parameter_number	Int	6.0	1120	<input checked="" type="checkbox"/>	<input checked="" type="checkbox"/>	Address: Parameter number
9	A_1_Index	Int	8.0	0	<input checked="" type="checkbox"/>	<input checked="" type="checkbox"/>	Address: Index number
10	A_2_Attribute	Byte	10.0	B#16#10	<input checked="" type="checkbox"/>	<input checked="" type="checkbox"/>	Address: 16#10= parameter value
11	A_2_Number_of_indices	Byte	11.0	0	<input checked="" type="checkbox"/>	<input checked="" type="checkbox"/>	Address: Number od elements (0 to 234)
12	A_2_Parameter_number	Int	12.0	1121	<input checked="" type="checkbox"/>	<input checked="" type="checkbox"/>	Address: Parameter number
13	A_2_Index	Int	14.0	0	<input checked="" type="checkbox"/>	<input checked="" type="checkbox"/>	Address: Index number
14	A_3_Attribute	Byte	16.0	B#16#10	<input checked="" type="checkbox"/>	<input checked="" type="checkbox"/>	Address: 16#10= parameter value
15	A_3_Number_of_indices	Byte	17.0	B#16#16	<input checked="" type="checkbox"/>	<input checked="" type="checkbox"/>	Address: Number od elements (0 to 234)
16	A_3_Parameter_number	Int	18.0	945	<input checked="" type="checkbox"/>	<input checked="" type="checkbox"/>	Address: Parameter number
17	A_3_Index	Int	20.0	0	<input checked="" type="checkbox"/>	<input checked="" type="checkbox"/>	Address: Index number

Figure 5-11: DB 103 for the response of the converter (read job)

G120\_at\_S7-300F-PN > PLC\_1 [CPU 315F-2 PN/DP] > Program blocks > answer\_from\_drive [DB103]

answer_from_drive							
	Name	Data type	Offset	Start value	Retain	Visible in ...	Comment
1	Static						
2	H_Reference	B...	0.0	0	<input checked="" type="checkbox"/>	<input checked="" type="checkbox"/>	HEAD: Reference number (mirrored)
3	H_Response_ID	Byte	1.0	0	<input checked="" type="checkbox"/>	<input checked="" type="checkbox"/>	HEAD: Response ID: 8xh=error, 0xh=ok
4	H_Axis	Byte	2.0	0	<input checked="" type="checkbox"/>	<input checked="" type="checkbox"/>	HEAD: Always 1 for SINAMICS G120
5	H_Number_of_parameters	Byte	3.0	0	<input checked="" type="checkbox"/>	<input checked="" type="checkbox"/>	HEAD: Number od parameters to transfer
6	V_1_Format	Byte	4.0	0	<input checked="" type="checkbox"/>	<input checked="" type="checkbox"/>	Value: Format of parameter value (44h=error)
7	V_1_Number_of_index_valu	Byte	5.0	0	<input checked="" type="checkbox"/>	<input checked="" type="checkbox"/>	Value: Number of index values
8	V_1_Value	Real	6.0	0.0	<input checked="" type="checkbox"/>	<input checked="" type="checkbox"/>	Value: Parameter value
9	V_2_Format	Byte	10.0	0	<input checked="" type="checkbox"/>	<input checked="" type="checkbox"/>	Value: Format of parameter value
10	V_2_Number_of_index_valu	Byte	11.0	0	<input checked="" type="checkbox"/>	<input checked="" type="checkbox"/>	Value: Number of index values
11	V_2_Value	Real	12.0	0.0	<input checked="" type="checkbox"/>	<input checked="" type="checkbox"/>	Value: Parameter value
12	V_3_Format	Byte	16.0	0	<input checked="" type="checkbox"/>	<input checked="" type="checkbox"/>	Value: Format of parameter value
13	V_3_Number_of_index_valu	Byte	17.0	0	<input checked="" type="checkbox"/>	<input checked="" type="checkbox"/>	Value: Number of index values
14	V_3_Value_00	Word	18.0	0	<input checked="" type="checkbox"/>	<input checked="" type="checkbox"/>	Value: Parameter value
15	V_3_Value_01	Word	20.0	0	<input checked="" type="checkbox"/>	<input checked="" type="checkbox"/>	Value: Parameter value
16	V_3_Value_02	Word	22.0	0	<input checked="" type="checkbox"/>	<input checked="" type="checkbox"/>	Value: Parameter value
17	V_3_Value_03	Word	24.0	0	<input checked="" type="checkbox"/>	<input checked="" type="checkbox"/>	Value: Parameter value
18	V_3_Value_04	Word	26.0	0	<input checked="" type="checkbox"/>	<input checked="" type="checkbox"/>	Value: Parameter value
19	V_3_Value_05	Word	28.0	0	<input checked="" type="checkbox"/>	<input checked="" type="checkbox"/>	Value: Parameter value
20	V_3_Value_06	Word	30.0	0	<input checked="" type="checkbox"/>	<input checked="" type="checkbox"/>	Value: Parameter value
21	V_3_Value_07	Word	32.0	0	<input checked="" type="checkbox"/>	<input checked="" type="checkbox"/>	Value: Parameter value
22	V_3_Value_08	Word	34.0	0	<input checked="" type="checkbox"/>	<input checked="" type="checkbox"/>	Value: Parameter value
23	V_3_Value_09	Word	36.0	0	<input checked="" type="checkbox"/>	<input checked="" type="checkbox"/>	Value: Parameter value
24	V_3_Value_10	Word	38.0	0	<input checked="" type="checkbox"/>	<input checked="" type="checkbox"/>	Value: Parameter value
25	V_3_Value_11	Word	40.0	0	<input checked="" type="checkbox"/>	<input checked="" type="checkbox"/>	Value: Parameter value
26	V_3_Value_12	Word	42.0	0	<input checked="" type="checkbox"/>	<input checked="" type="checkbox"/>	Value: Parameter value
27	V_3_Value_13	Word	44.0	0	<input checked="" type="checkbox"/>	<input checked="" type="checkbox"/>	Value: Parameter value
28	V_3_Value_14	Word	46.0	0	<input checked="" type="checkbox"/>	<input checked="" type="checkbox"/>	Value: Parameter value
29	V_3_Value_15	Word	48.0	0	<input checked="" type="checkbox"/>	<input checked="" type="checkbox"/>	Value: Parameter value

5.2 Parameter access functionality

5.2.3 FB 20 "Parameter\_Access"

In the example, the parameters are accessed in FB 20 "Parameter\_Access". It is called cyclically in OB 1.

Figure 5-12: FB20 „Parameter\_Access"

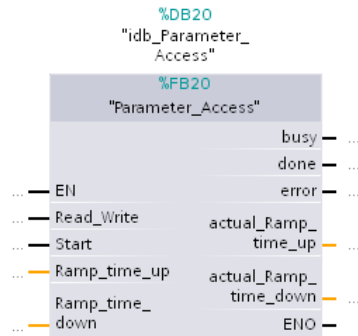

Table 5-5: Interface assignment of FB 20 "Parameter\_Access"

Name	Type	Function
<b>Inputs</b>		
Read_Write	BOOL	0= Read parameters 1= Write parameters
Start	BOOL	A rising edge starts the transfer, the FB automatically sets the signal back to 0
Ramp_time_up	REAL	Ramp up time to be written
Ramp_time_down	REAL	Ramp down time to be written
<b>Outputs</b>		
busy	BOOL	Access in progress
done	BOOL	Access successful
error	BOOL	Access aborted with an error
actual_Ramp_time_up	REAL	Read ramp up time
actual_Ramp_time_down	REAL	Read ramp down time

Setup

The FB 20 "Parameter\_Access" consists of two parts:

- a step chain which controls the sequence of the parameter access. (Networks 1 to 9)
- call of the system functions "Write data record" or "Read data record". (network 10).

5.2 Parameter access functionality

Step chain

The individual steps of FB 20 "Parameter\_Access" are represented in the following graphic. The possible transitions between the individual steps are also displayed there.

Figure 5-13: Step chain parameter access

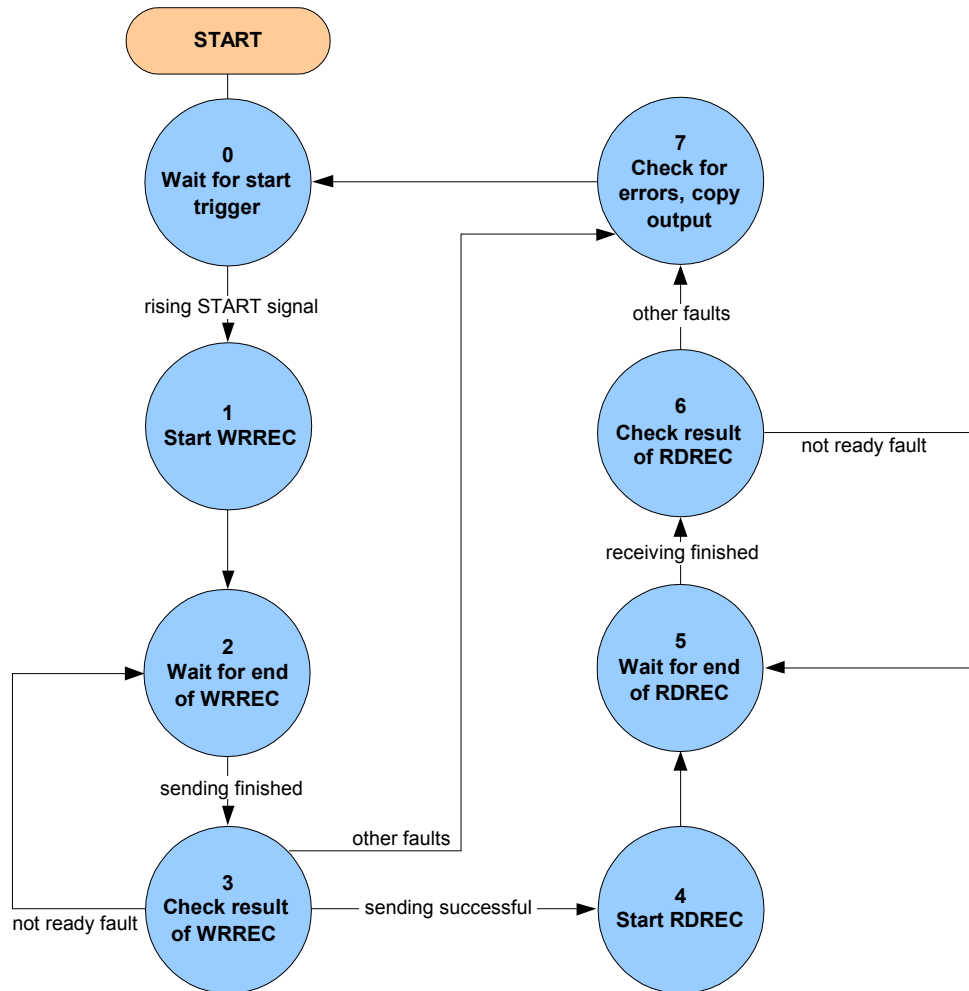

In the individual states of the step chain, the following functions are executed:

Table 5-6: Function of the states of FB 20 "Parameter\_Access"

State		Function
0	Wait for start trigger	It is waited for a rising edge of the "Start" signal. If it is detected, all output signals are deleted, "busy" is set and step 1 is activated.
1	Start WRREC	The "Start" signal is reset, the "REQ" signal of the "WRREC" instruction is set and step 2 is activated.
2	Wait for end of WRREC	It is waited until the "BUSY" signal of the "RDREC" instruction becomes 0 again. Then step 3 is activated.

**5.2 Parameter access functionality**

State		Function
3	Check result of WRREC	It is checked whether the data record was written successfully. If yes, the "REQ" signal of the "WRREC" instruction is deleted again and step 4 is activated. If the "WRREC" instruction reports error 16#DF80_B500 (peer not ready), step 3 is activated again so that "WRREC" repeats the job. If a different error has occurred, the "REQ" signal of the "WRREC" instruction is deleted, an internal error bit is set and step 7 is activated.
4	Start RDREC	The "REQ" signal of the "RDREC" instruction is set and step 5 is activated.
5	Wait for end of RDREC	It is waited until the "BUSY" signal of the "RDREC" instruction becomes 0 again. Then step 6 is activated.
6	Check result of RDREC	It is checked whether the data record was read successfully. If yes, the "REQ" signal of the "RDREC" instruction is deleted again and step 7 is activated. If "RDREC" reports error 16#DE80_B500 (peer not ready), step 5 is activated again so that the "RDREC" instruction repeats the job. If a different error has occurred, the "REQ" signal of the "RDREC" instruction is deleted, an internal error bit is set and step 7 is activated.
7	Check for errors, copy outputs	It is checked whether one of the internal error bits is set or whether an error bit has been set in the response of the converter. In the event of an error <ul style="list-style-type: none"> <li>- the "error" output parameter of FB 20 is set,</li> <li>- the "busy" output parameter of FB 20 is deleted,</li> <li>- 999999.9s is output as read time and</li> <li>- step 0 is activated.</li> </ul> If no error bit has been set, the read times are output, the "busy" output parameter of FB 20 is deleted and step 0 is activated.

© Siemens AG 2014. All rights reserved

**Calling the system functions "Write data record" or "Read data record"**

Once the currently required control bits have been set in the sequence chart of FB 20 "Parameter\_Access", the "WRREC" instruction for writing the data record and the "RDRE" instruction for reading the data record are called in network 10. They can be found in the "instructions" task card of the TIA Portal under...

- > Extended Instructions
- > Distributed I/O

Via the "Read\_Write" input variable it is selected which of the two calls enables the "WRREC" instruction. Both calls only differ in which DB is sent to the drive: the one to write parameters or the one to read parameters.

## 5.3 Safety functionality

## 5.3 Safety functionality

Figure 5-14: Block structure of safety functions

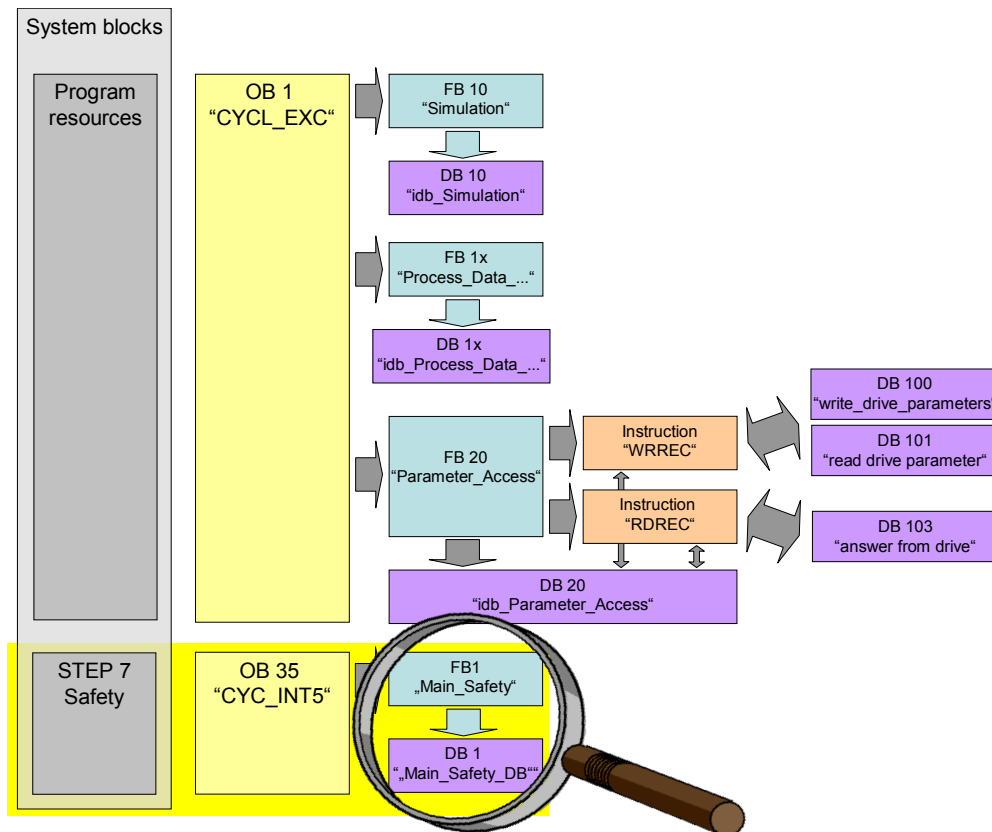

## 5.3.1 Configuration/settings

To be able to enable the transfer of safety-related data with PROFIsafe, two steps have to be performed.

- **S7-CPU**  
The PROFIsafe Telegram 30 or 900 is inserted when configuring the telegrams of the SINAMICS G120 under "Devices and Networks". The telegram 30 enables the use of the standard safety functions of the SINAMICS G 120, the telegram 900 that of the extended safety functions and the transmission of failsafe inputs of the SINAMICS G120.
- **SINAMICS G120**  
Enabling the PROFIsafe telegram is performed automatically by using the respective safety functions.  
If the PROFIsafe telegram 900 was used for the configuration of the S7-CPU, the transmission of the F-DI signal states has to be enabled.

## 5.3.2 FB 1 "Main\_Safety"

When programming the safety-related program parts, only the normal restrictions and programming rules for distributed safety have to be observed.

The F program of the example (FB 1) is limited to linking each signal of a safe input of the SINAMICS G120 to a binary signal of the F-DI module "and", and to use the result to control/disable a safety function.

**5.3 Safety functionality**

Furthermore the passivation bits of the F-DI module and the drive are read in and the acknowledgement signal is used for the reintegration of the two 'modules'.

The safety bits of the converter can be accessed just as the bits of F-DI/DOs in the safety program:

- In the example the input bytes 16 and 17 receive the PROFIsafe status word 1 and the input bytes 18 and 19 receive the PROFIsafe control word 5 of the PROFIsafe telegram 900.
- In the example, the PROFIsafe control word 1 of the PROFIsafe telegram 900 is sent to the drive via the output bytes 16 und 17.

**5.3.3 Safety control and status words**

Figure 5-15 Safety control word 1

Bit	Meaning	Comment			
0	STO	1	STO is deselected		
		0	STO is selected		
1	SS1	1	SS1 is deselected		
		0	SS1 is selected		
2, 3	<i>Reserved</i>				
4	SLS	1	SLS is deselected		
		0	SLS is selected		
5, 6	<i>Reserved</i>				
7	Internal event ack	1	Acknowledge serious safety function faults with a signal change 1 → 0		
		0	Do not acknowledge faults		
8	<i>Reserved</i>				
9	SLS-level, bit 0	Selection of the SLS level		Bit 10	Bit 9
10	SLS-level, bit 1		Level 1	0	0
			level 2	0	1
			level 3	1	0
		level 4	1	1	
11	<i>Reserved</i>				
12	SDI Positive	1	SDI with positive direction of rotation is deselected		
		0	SDI with positive direction of rotation is selected		
13	SDI Negative	1	SDI with negative direction of rotation is deselected		
		0	SDI with negative direction of rotation is selected		
14, 15	<i>Reserved</i>				

The safety control word 5 only consists of reserved bits.

5.3 Safety functionality

Figure 5-16 Safety status word 1

Bit	Meaning	Comment			
0	Power removed	1	STO is active		
		0	STO is not active		
1	SS1 active	1	SS1 is active		
		0	SS1 is not active		
2, 3	Reserved				
4	SLS active	1	SLS is active		
		0	SLS is not active		
5, 6	Reserved				
7	Internal Event	1	The converter has detected a severe fault in the safety functions.		
		0	Fault-free operation		
8	Reserved				
9	SLS-level, bit 0	Active SLS level		Bit 10	Bit 9
10	SLS-level, bit 1		Level 1	0	0
			level 2	0	1
			level 3	1	0
		level 4	1	1	
11	Reserved				
12	SDI positive active	1	SDI positive direction of rotation is active		
		0	SDI positive direction of rotation is not active		
13	SDI negative active	1	SDI negative direction of rotation is active		
		0	SDI negative direction of rotation is not active		
14	Reserved				
15	Status SSM	1	Speed is within the SSM limit value		
		0	Speed is outside the SSM limit value		

Figure 5-17 Safety status word 5

Bit	Meaning	Comment	SINAMICS G120	SINAMICS G120D			
0 ... 7	Reserved	-					
8	Status of fail-safe inputs	0	LOW signal (0 V)	At terminals 5 and 6	At pins X7.2 and X7.4		
		1	HIGH signal (24 V)				
		9		0	LOW signal (0 V)	At terminals 7 and 8	At pins X8.2 and X8.4
				1	HIGH signal (24 V)		
10		0	LOW signal (0 V)	At terminals 16 and 17	At pins X9.2 and X9.4		
		1	HIGH signal (24 V)				
11 ... 15	Reserved	-					

5.3.4 PROFIsafe addresses

The PROFIsafe addresses (F source address, F destination address) are used to uniquely identify source and destination. They have to be unique across the network and station. In order to prevent incorrect configuration, they are uniquely assigned automatically across the station in the TIA Portal when placing an F module in the work area of the device or network view. In the event that several PROFINET IO systems and/or DP master systems have to be operated in a network, you have to set the "Basis for PROFIsafe addresses" parameter



### 5.3 Safety functionality

(parameter in the object properties of the F-CPU) before placing the F I/O in the various stations of a network in order to uniquely assign the PROFIsafe addresses.

#### F-DI module

The F destination address has to be set on the F-DI module with a ten-pin DIP switch according to the configuration in the TIA Portal.

#### Drive

Within the framework of the configuration of the safety functions of the SINAMICS G120 with STARTER, the F destination address has to be set according to the configuration in the TIA Portal.

Details for setting the PROFIsafe addresses can be found in the step tables in chapter 6 "Configuration and Settings".

## 6 Configuration and Settings

**Note** If you only wish to download and commission the example program, please follow the instructions in chapter 3 "Setting up and Commissioning the Application".

The step tables below describe what you have to do if you do not want to or cannot use the sample code and you want to or have to configure SINAMICS G120 and SIMATIC S7 CPU yourself.

### 6.1 Configuring the S7-300/400 controller

This chapter describes how the S7-300/400 must be configured for the example program. This chapter does not discuss integrating the operator panel or programming the S7-300/400.

**Note** The screenshots below use a general STEP 7 project name: "G120\_at\_S7". In this example, this stands for "G120\_at\_S7-300F-PN".

#### Requirements

The STEP 7 software according to Table 2-2 is installed on your development system.

Table 6-1: Instruction for configuring the S7-300/400 controller

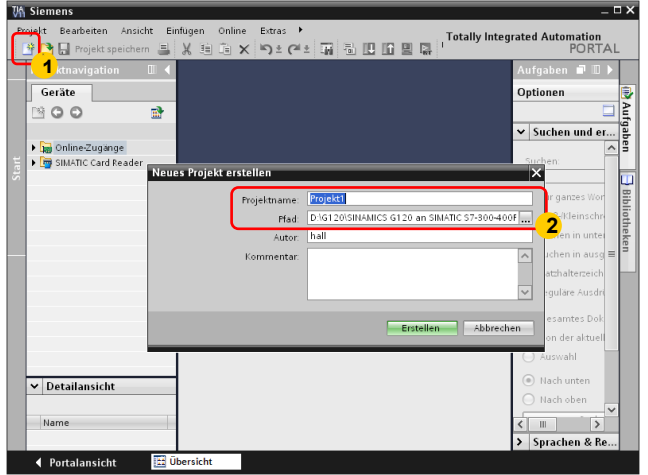
No.	Action	Remarks
1.	Start the TIA Portal. Go to project view if the portal view has opened.	
2.	Create a new project. Assign a project name and select a storage path.	

## 6 Configuration and Settings

### 6.1 Configuring the S7-300/400 controller

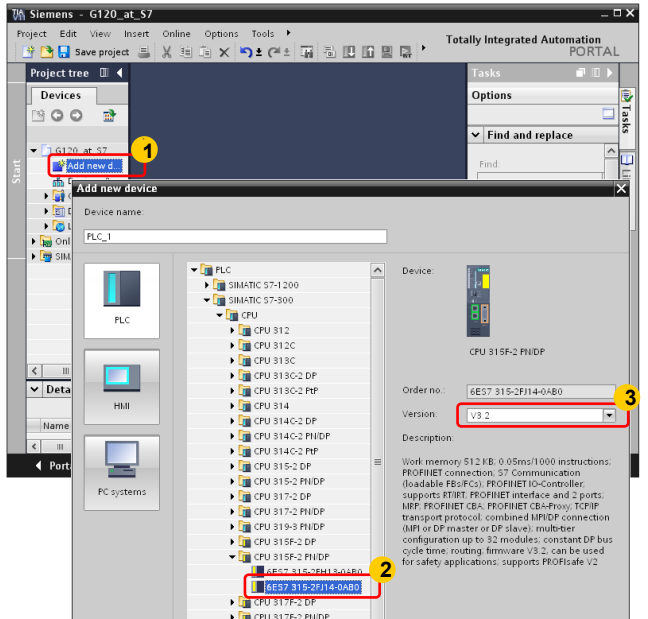
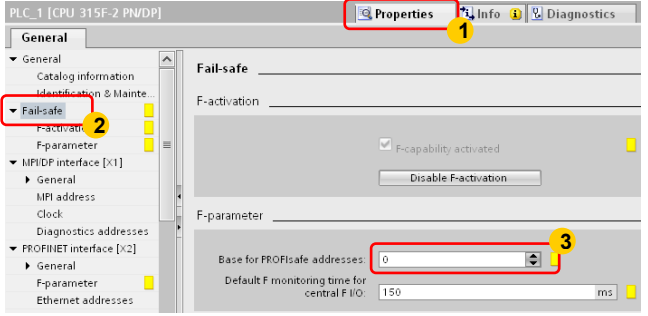
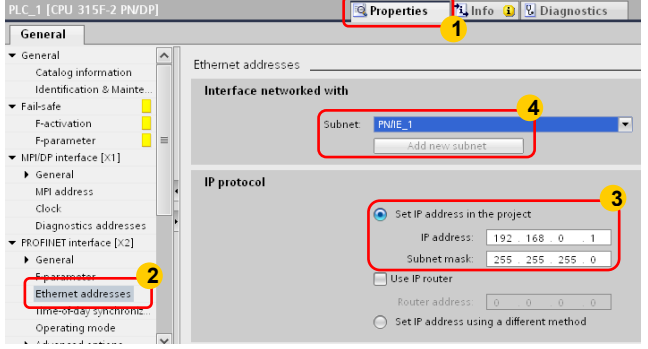
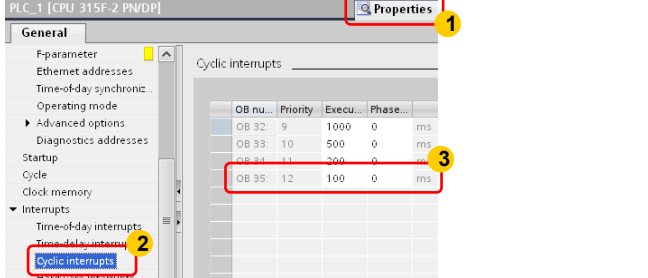
No.	Action	Remarks
3.	<p>Insert your CPU.</p> <p>Make sure that the firmware versions match.</p> <p>Used in the example project: CPU 315F-2 PN/DP (6ES7 315-2FJ14-0AB0)</p>	
4.	<p>Open the "Properties" in the device configuration of the CPU and check the PROFIsafe address basis in the "Failsafe" menu item.</p> <p>In the example project: „0"</p> <p>The value 0 signifies that the automatic assignment of the PROFIsafe destination addresses starts from address 0.</p>	
5.	<p>Configure the PROFINET interface.</p> <p>Go to "Ethernet addresses" in the tree. Select "Set IP address in the project" and enter the desired IP address.</p> <p>Add a new subnet and select it.</p>	
6.	<p>Check the time interval of the cyclic interrupt in OB 35 that is used for the safety program.</p> <p>In the example project: 100 ms (default value)</p>	

## 6 Configuration and Settings

### 6.1 Configuring the S7-300/400 controller

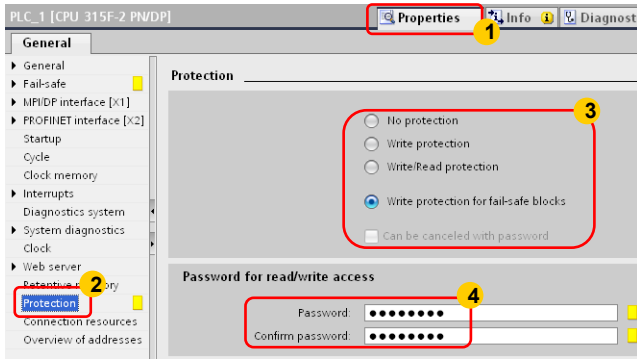
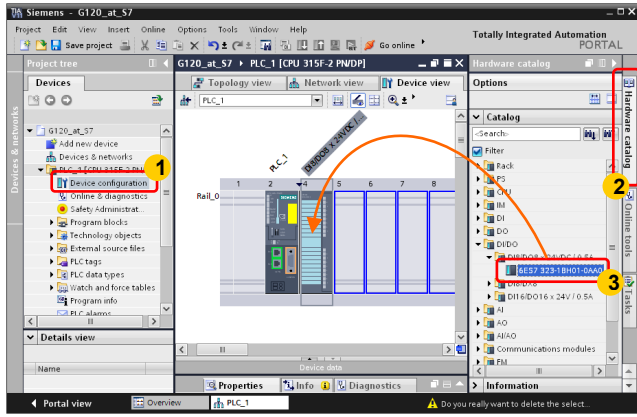
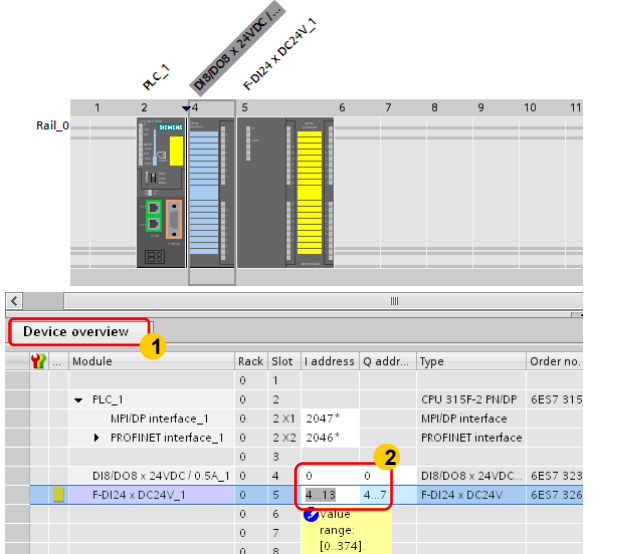
No.	Action	Remarks																																																																						
7.	<p>Set the desired protection level: Depending on the configured protection level, read or write online accesses to the CPU are only possible if the correct password was entered at the PG/PC.</p> <p>In the example project: "Write protection for fail-safe blocks" password: "siemens"</p>	 <p>PLC_1 [CPU 315F-2 PN/DP] Properties</p> <p><b>General</b></p> <ul style="list-style-type: none"> <li>General</li> <li>Fail-safe</li> <li>MPI/DP interface [x1]</li> <li>PROFINET interface [x2]</li> <li>Startup</li> <li>Cycle</li> <li>Clock memory</li> <li>Interrupts</li> <li>Diagnostics system</li> <li>System diagnostics</li> <li>Clock</li> <li>Web server</li> <li>Protection</li> <li>Connection resources</li> <li>Overview of addresses</li> </ul> <p><b>Protection</b></p> <p> <input type="radio"/> No protection  <input type="radio"/> Write protection  <input type="radio"/> Write/Read protection  <input checked="" type="radio"/> Write protection for fail-safe blocks  <input type="checkbox"/> Can be canceled with password     </p> <p><b>Password for read/write access</b></p> <p>Password: ..... Confirm password: .....</p>																																																																						
8.	<p>Open "Device configuration" and drag the required modules from the hardware catalog to the rack.</p> <p>Used in the example project:</p> <ul style="list-style-type: none"> <li>DI8/DO8 x DC24V / 0,5A (6ES7 323-1BH01-0AA0) to slot 4</li> <li>F-DI24 x DC24V (6ES7 326-1BK02-0AB0) to slot 5</li> </ul>	 <p>Siemens - G120_at_S7</p> <p>Hardware Catalog</p> <p>Project tree: G120_at_S7 &gt; PLC_1 [CPU 315F-2 PN/DP]</p> <p>Devices: Device configuration</p> <p>Options: Hardware catalog, Filter, Search, Rack, CPU, DI, DO, DI&amp;DO16 x 24V / 0.5A, DI&amp;DO16 x 24V / 0.5A, AO, AI/AO, Communications modules, EM</p> <p>Information: Do you really want to delete the select.</p>																																																																						
9.	<p>If required change the I/O addresses of the newly inserted modules in the device overview.</p> <p>in the example project: DI8/DO8....: I/O start address 0 F-DI24....: I/O start address 1</p>	 <p>Device Overview</p> <table border="1"> <thead> <tr> <th>Module</th> <th>Rack</th> <th>Slot</th> <th>I address</th> <th>Q addr...</th> <th>Type</th> <th>Order no.</th> </tr> </thead> <tbody> <tr> <td>PLC_1</td> <td>0</td> <td>1</td> <td></td> <td></td> <td>CPU 315F-2 PN/DP</td> <td>6ES7 315</td> </tr> <tr> <td>MPI/DP interface_1</td> <td>0</td> <td>2</td> <td>2047*</td> <td></td> <td>MPI/DP interface</td> <td></td> </tr> <tr> <td>PROFINET interface_1</td> <td>0</td> <td>2</td> <td>2046*</td> <td></td> <td>PROFINET interface</td> <td></td> </tr> <tr> <td></td> <td>0</td> <td>3</td> <td></td> <td></td> <td></td> <td></td> </tr> <tr> <td>DI8/DO8 x 24VDC / 0.5A_1</td> <td>0</td> <td>4</td> <td>0</td> <td>0</td> <td>DI8/DO8 x 24VDC...</td> <td>6ES7 323</td> </tr> <tr> <td>F-DI24 x DC24V_1</td> <td>0</td> <td>5</td> <td>1</td> <td>4..7</td> <td>F-DI24 x DC24V</td> <td>6ES7 326</td> </tr> <tr> <td></td> <td>0</td> <td>6</td> <td></td> <td></td> <td></td> <td></td> </tr> <tr> <td></td> <td>0</td> <td>7</td> <td></td> <td></td> <td></td> <td></td> </tr> <tr> <td></td> <td>0</td> <td>8</td> <td></td> <td></td> <td></td> <td></td> </tr> </tbody> </table> <p>value range: [0..374]</p>	Module	Rack	Slot	I address	Q addr...	Type	Order no.	PLC_1	0	1			CPU 315F-2 PN/DP	6ES7 315	MPI/DP interface_1	0	2	2047*		MPI/DP interface		PROFINET interface_1	0	2	2046*		PROFINET interface			0	3					DI8/DO8 x 24VDC / 0.5A_1	0	4	0	0	DI8/DO8 x 24VDC...	6ES7 323	F-DI24 x DC24V_1	0	5	1	4..7	F-DI24 x DC24V	6ES7 326		0	6						0	7						0	8				
Module	Rack	Slot	I address	Q addr...	Type	Order no.																																																																		
PLC_1	0	1			CPU 315F-2 PN/DP	6ES7 315																																																																		
MPI/DP interface_1	0	2	2047*		MPI/DP interface																																																																			
PROFINET interface_1	0	2	2046*		PROFINET interface																																																																			
	0	3																																																																						
DI8/DO8 x 24VDC / 0.5A_1	0	4	0	0	DI8/DO8 x 24VDC...	6ES7 323																																																																		
F-DI24 x DC24V_1	0	5	1	4..7	F-DI24 x DC24V	6ES7 326																																																																		
	0	6																																																																						
	0	7																																																																						
	0	8																																																																						

## 6 Configuration and Settings

### 6.1 Configuring the S7-300/400 controller

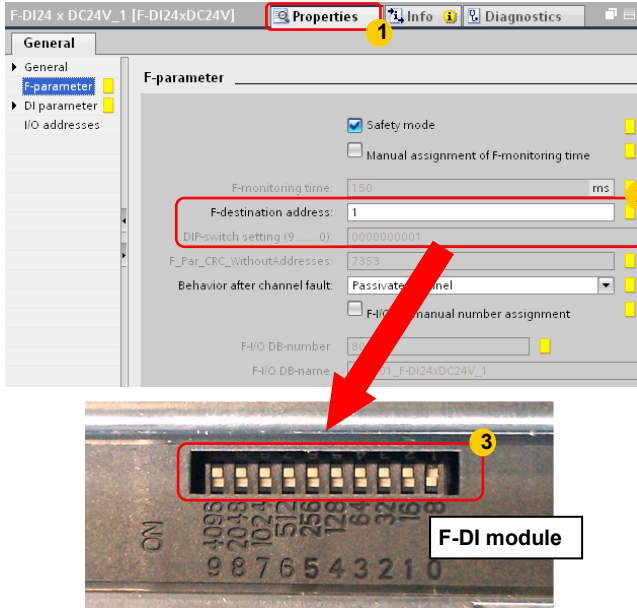
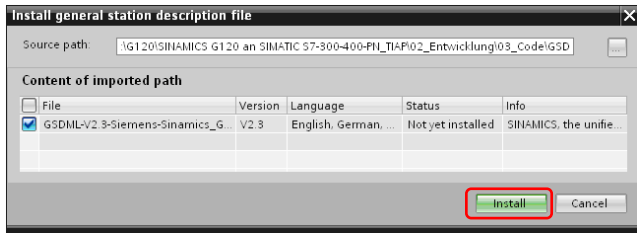
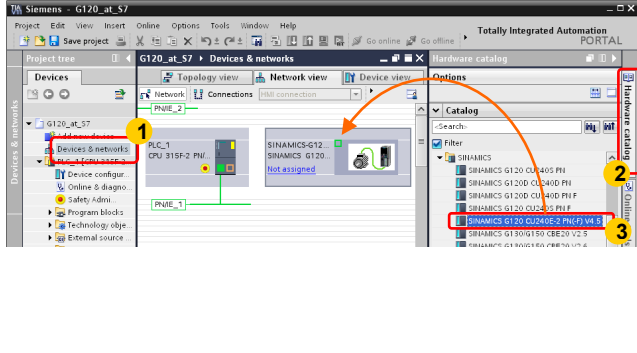
No.	Action	Remarks
10.	<p>Go to the properties of the F I/O module (here F-DI) under "F-parameter" and memorize the F destination address that is entered there by the system or the bit pattern of the specified DIL switch position.</p> <p>Set the F destination address with the DIL switch on the back of the F I/O module (here F-DI) to the memorized value.</p> <p>In the example project:            F-destination address: 1            DIL switch: 0000000001</p>	 <p>The screenshot shows the 'Properties' dialog for the F-DI24 x DC24V_1 module. The 'F-parameter' tab is selected. The 'F-destination address' is set to 1. The 'DIP-switch setting' is 0000000001. A red box highlights these two fields. A red arrow points from the screenshot to a photograph of the physical F-DI module, where a red box highlights the DIP switch labeled '1'.</p>
11.	<p>Now install the GSD file that corresponds to the control unit of the drive if not done yet.</p> <p>For this purpose, close the hardware and the network editor.</p> <p>Load the archived GSDML file from the respective Online Support page (see <a href="#">V4</a>) to your PG/PC and retrieve it.</p> <p>Open the dialog to select the required GSD in the TIA Portal and install it via            &gt;Options            &gt;Device description files.</p>	 <p>The screenshot shows the 'Install general station description file' dialog box. The 'Source path' is set to 'G:\G120\SINAMICS G120 an SIMATIC S7-300-400-PN_TIAPI02_Entwicklung\03_Code\GSD'. The 'Content of imported path' table shows a file 'GSDML-V2 3-Siemens-Sinamics_G...' with version V2.3, language English, German, and status 'Not yet installed'. The 'Install' button is highlighted with a red box.</p>
12.	<p>Go to the network view and open the hardware catalog.</p> <p>Drag the desired drive into the graphic area of the network view.</p> <p>Use the drive            "SINAMICS G120 CU240E-2 PN-(F) V4.5"</p> <p>from the catalog path            &gt;Other field devices            &gt;PROFINET IO            &gt;Drives            &gt;Siemens AG            &gt;SINAMICS</p>	 <p>The screenshot shows the TIA Portal 'Network view' with the hardware catalog open. The drive 'SINAMICS G120 CU240E-2 PN-(F) V4.5' is selected in the catalog. A red box highlights the drive in the catalog. A red arrow points from the drive in the catalog to the network view, where it is being dragged into the graphic area.</p>

## 6 Configuration and Settings

### 6.1 Configuring the S7-300/400 controller

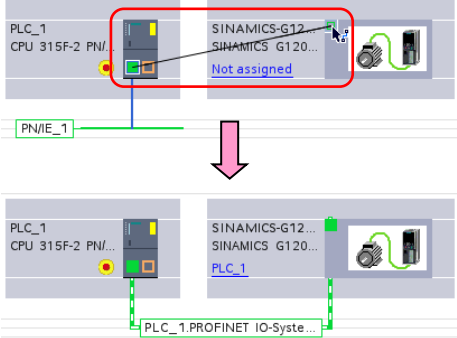
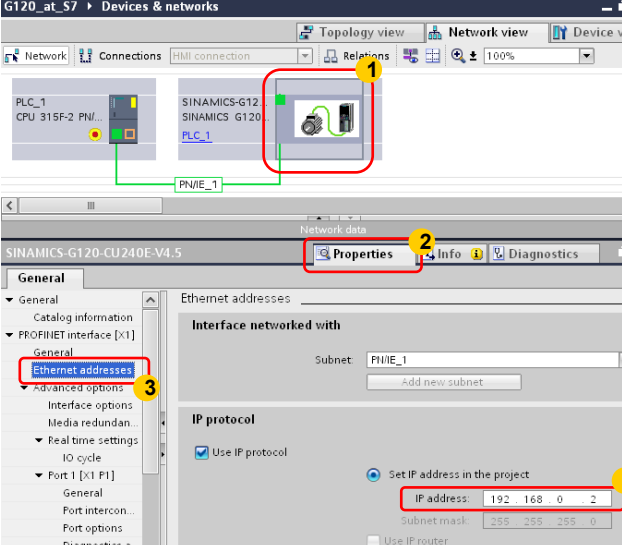
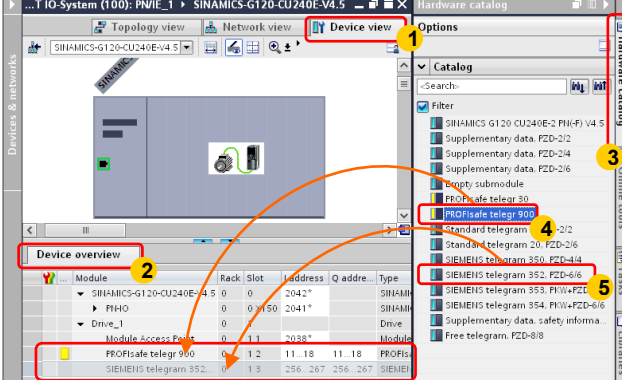
No.	Action	Remarks
13.	<p>Connect the IO device (drive) via PROFINET with the CPU.</p> <p>For this purpose drag a line with the mouse button pushed down between the Ethernet connections of the two devices.</p> <p>The drive automatically contains the next free IP address.</p>	
14.	<p>If required, change the IP address of the drive.</p> <p>To be able to do this click the drive and select the "Properties" tab. Subsequently open the "Ethernet addresses" menu item.</p> <p>In the example project: IP address: 192.168.0.2 (default value)</p>	
15.	<p>Select the data records to be transferred.</p> <p>For this purpose, go to the device view of the drive and open the device view.</p> <p>Subsequently drag the desired telegrams from the catalog into the device view.</p> <p>In the example project: „PROFIsafe teleg 900“ „SIEMENS telegram 352, PZD-6/6“</p>	
16.	<p>If required, change the I/O addresses of the telegram in the above device overview.</p>	<p>L=EN-US&gt;In order to be compatible with the program code of the example project, the I/O addresses of the PROFIsafe The I/O addresses of the SIEMENS telegram 352 contain the default value"256".</p>

## 6 Configuration and Settings

### 6.1 Configuring the S7-300/400 controller

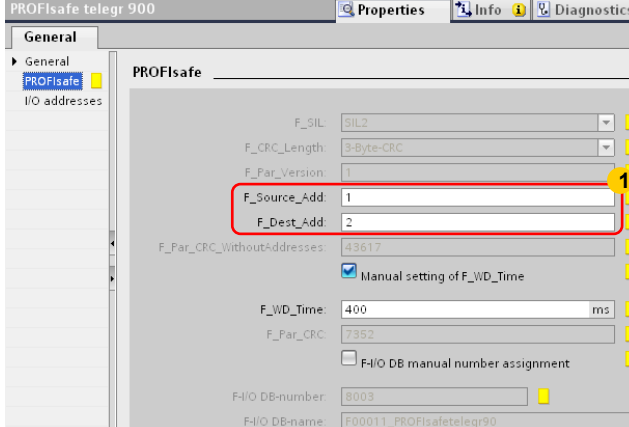
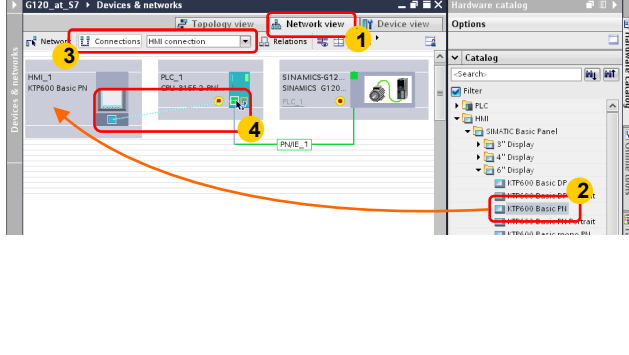
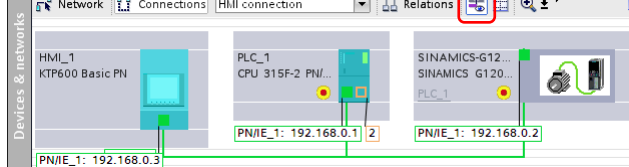
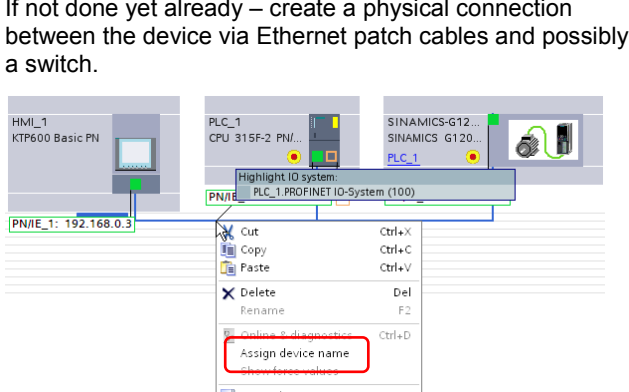
No.	Action	Remarks
17.	<p>Open the properties of the "PROFIsafe Telegram 900" by double clicking the telegram the device overview.</p> <p>If required, adjust the PROFIsafe addresses to your drive or memorize the default addresses F_Source_Add and F_Dest_Add entered here in order to configure the drive with them.</p>	
18.	<p>Go to the network view again.</p> <p>Configure the operator panel by dragging "KTP600 Basic PN" from the catalog to the workspace.</p> <p>Enable the connection mode and select "HMI connection" from the drop-down list.</p> <p>Create a connection graphically between the Ethernet connections of the KTP600 and the PLC by dragging the mouse.</p>	
19.	<p>Show the addresses.</p> <p>The KTP600 is automatically assigned to the next free the IP address 192.168.0.2.</p>	
20.	<p>Assign the devices their PROFINET device name online, if not done yet already in a different way.</p> <p>For this purpose, make a right click on the PROFINET IO system in the graphic area of the network view and select "Assign device name" from the context menu.</p>	<p>If not done yet already – create a physical connection between the device via Ethernet patch cables and possibly a switch.</p> 

6.1 Configuring the S7-300/400 controller

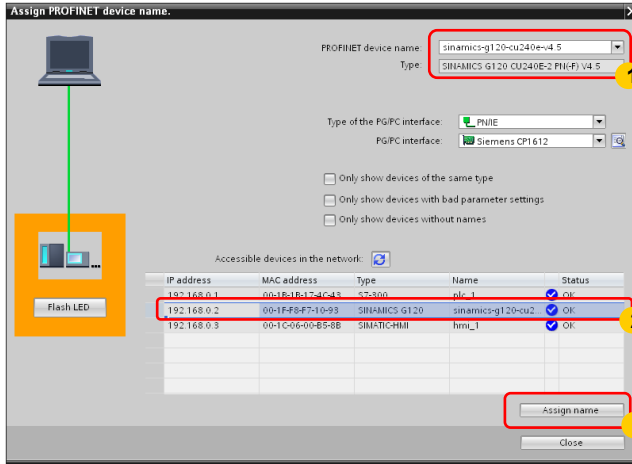
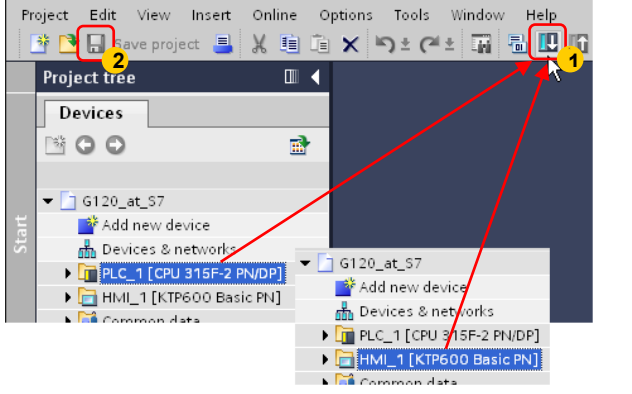
No.	Action	Remarks
21.	<p>All available PROFINET IO nodes are listed.</p> <p>Now successively assign each device the configured PROFINET device name and click "Assign name".</p> <p>Select the names from the drop-down list on the top right.</p> <p>Afterwards refresh the window with  and check the data transfer.</p>	 <p>The PROFINET device names themselves cannot be changed. They are derived from the editable device name that the system assigns to each device by default in its "Properties" tab under "General".</p>
22.	<p>The device and network configuration is now completed.</p> <p>Successively compile the configurations of CPU and HMI device for control purposes. The compiling results can be seen in the inspection window. The CPU is compiled without errors. For the operator panel you only receive the error message that no start screen has been defined yet, since no images have probably been configured yet.</p> <p>Save the project.</p>	

**Note**

In order to use the safety data of the drive in the safety program, a safety program on the SIMATIC side is required. This is automatically created with the device configuration and its compilation. The user only has to program an FB "Main\_Safety" that has already been created by the system (included in the example program).

Further information is available in [\6\](#).





**6.2 Configuration of the SINAMICS G120 drive via Ethernet**

**6.2 Configuration of the SINAMICS G120 drive via Ethernet**

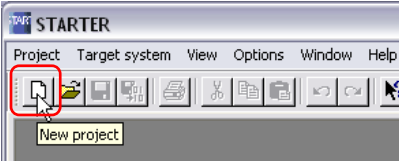
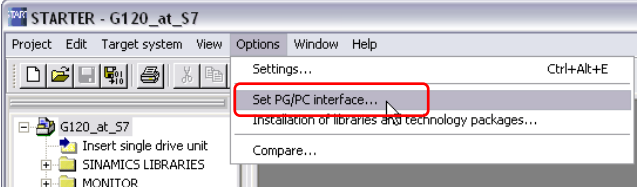

**Note** The screenshots below use a general STARTER project name: "G120\_at\_S7". In this example, this stands for "G120\_at\_S7-300-PN"

Table 6-2: Instruction drive configuration via PROFINET

No.	Action	Remarks
1.	Install the STARTER commissioning software (see also <a href="#">13</a> ).	
2.	Connect the SINAMICS G120 with your PG/PC using an Ethernet patch cable.	
3.	Start the STARTER commissioning software.	
4.	Create a new project.	
5.	Open "Set PG/PC interface".	

## 6 Configuration and Settings

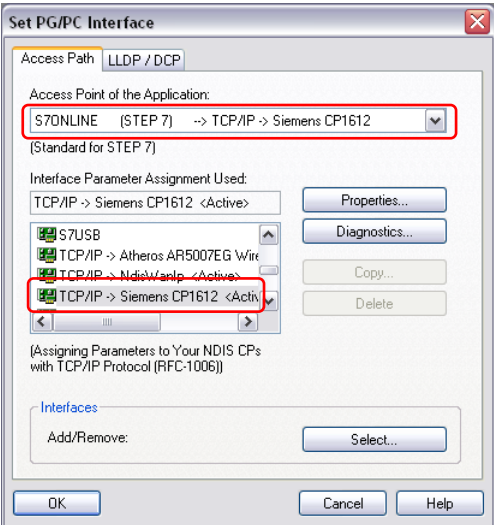
### 6.2 Configuration of the SINAMICS G120 drive via Ethernet

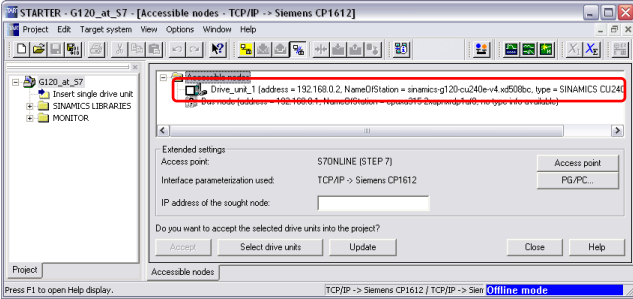
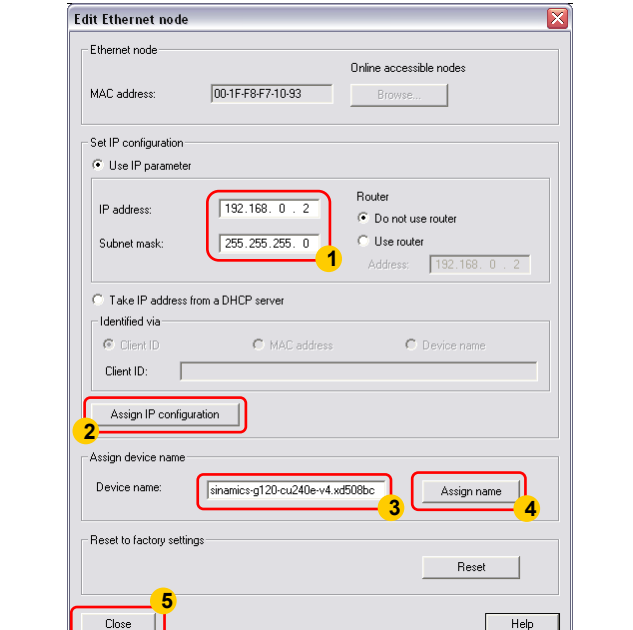
No.	Action	Remarks
6.	Select the access point of the application „S7ONLINE (STEP 7)“ and as interface parameter assignment used "TCP/IP ⇒ interface card used".	
7.	Click on "Accessible nodes".	
8.	Right click on the found drive and select "Edit Ethernet node..." from the context menu.	
9.	Assign or change the IP address and the device name of the drive if required.  In the example project: IP address 192.168.0.2 Subnet mask 255.255.255.0 Device name „sinamics-g120-cu240e-v4.xd508bc"	

## 6 Configuration and Settings

### 6.2 Configuration of the SINAMICS G120 drive via Ethernet

No.	Action	Remarks
10.	<ul style="list-style-type: none"> <li>Update the "Accessible nodes".</li> <li>Tick the found converter.</li> <li>Click "Accept".</li> <li>Click "Close".</li> </ul>	
11.	<p>Change the name of the drive unit according to your wishes. Right click the drive unit and select "Rename" in the context menu.</p>	
12.	Select the converter in the tree and go online.	
13.	Download the hardware configuration into the PG/PC.	
14.	Select the converter in the tree and then press "Restore factory settings".	

## 6 Configuration and Settings

### 6.2 Configuration of the SINAMICS G120 drive via Ethernet

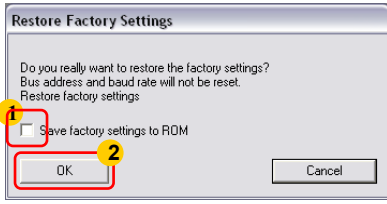
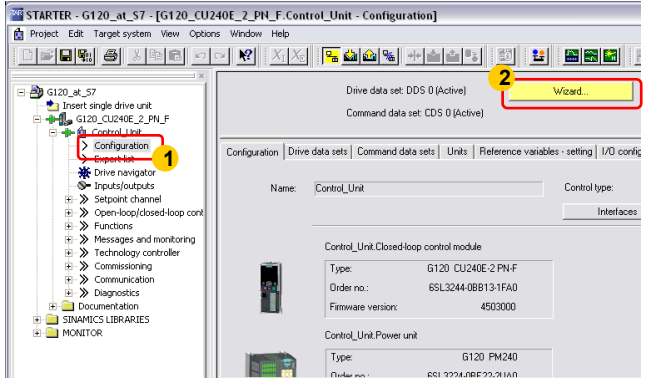
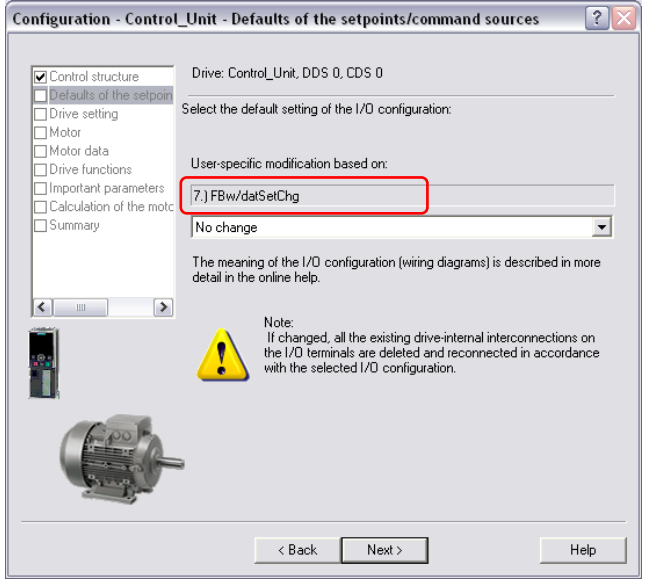
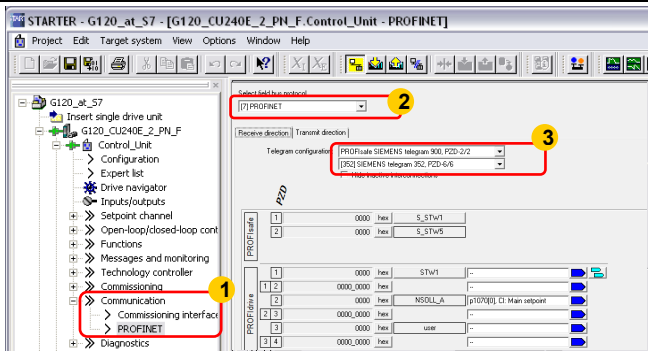
No.	Action	Remarks
15.	Remove the checkmark for "Save factory settings to ROM" and then click "OK".	
16.	Expand the tree and double click on "Configuration". Then call up the wizard.	
17.	Run the wizard and enter the data you need. Ensure that the field bus is selected in the "Defaults of the setpoint/command sources" step.	
18.	<p>Double click "Communication &gt; PROFINET" in the project navigation, select one of the tabs "Receive" or "Transmit direction", and select "PROFIsafe Siemens-Telegramm 900, PZD-2/2" and "Siemens telegram 352, PZD-6/6)".</p> <p>Note: The telegram type matches the example. It is decisive here, that the same telegram is selected as for the hardware configuration in STEP 7.</p>	

## 6 Configuration and Settings

### 6.2 Configuration of the SINAMICS G120 drive via Ethernet

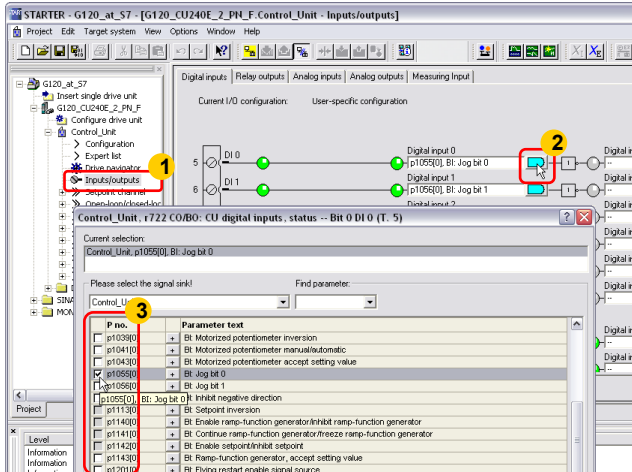
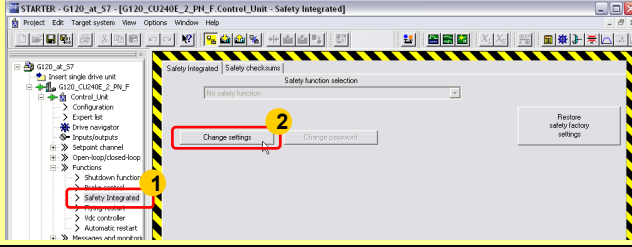
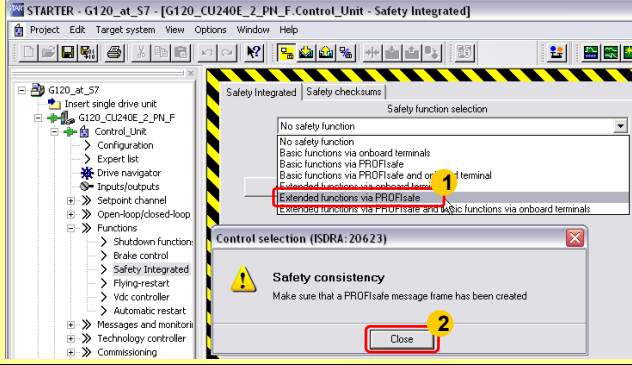
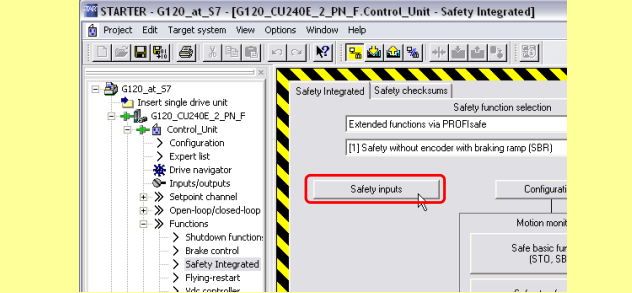
No.	Action	Remarks
19.	<ul style="list-style-type: none"> <li>Open "Input/outputs" in the project navigation.</li> <li>Click the turquoise field next to digital input 0.</li> <li>Remove all ticks in the "Control_Unit, ....D0 (terminal 5)" window that opens up and subsequently close this field with OK.</li> <li>Repeat the process for DI1 to DI5.</li> </ul>	 <p>DI 0 to DI 5 are to be used as fail-safe inputs. However, they will remain their function as standard inputs. When controlling the F-DI 0 (terminal 5+6) also those functions would be triggered that have been configured on DI 0 (terminal 5) and DI 1 (terminal 6) (typing bit 0/1). In order to avoid this, the functions of the standard inputs are deleted.</p>
20.	Open "Safety Integrated" in the project navigation and click "Change settings".	
21.	Select "Extended functions via PROFIsafe". Confirm that a safety telegram has been created.	
22.	Open the "Safety inputs" dialog.	

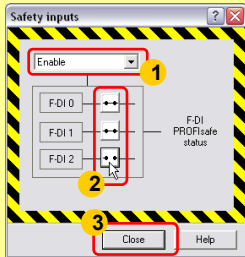
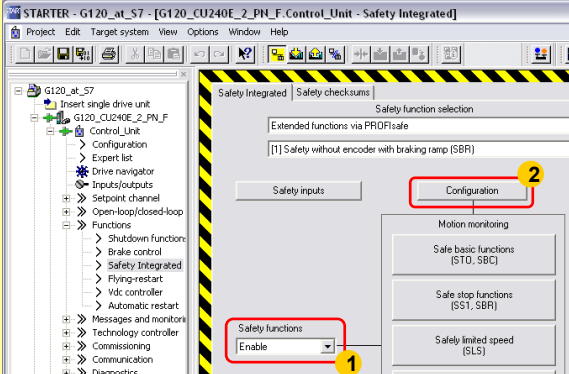
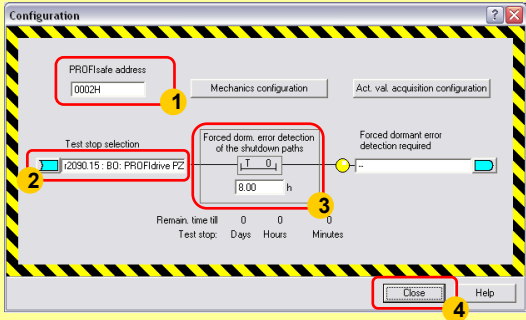
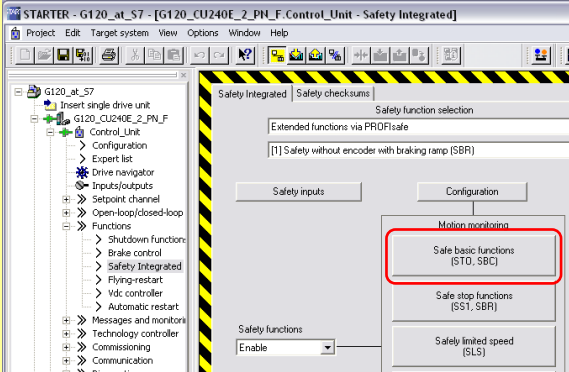

## 6 Configuration and Settings

### 6.2 Configuration of the SINAMICS G120 drive via Ethernet

No.	Action	Remarks
23.	<p>Enable the transfer of the inputs. For this purpose select "Enable" from the drop-down list and subsequently click the connecting buttons that correspond to the inputs. Close the dialog.</p>	
24.	<p>Set the enable of the safety functions. Open the "Configuration" dialog.</p>	
25.	<ul style="list-style-type: none"> <li>Enter the value F_Dest_Add (step 17 in Table 6-1) that was configured in the TIA Portal as hex number in the "PROFIsafe address" field.</li> <li>Select bit 15 of the control word, meaning "P2090.15" as "Test stop selection".</li> <li>Set the monitoring of the forced dormant error detection for the expanded functions to 8h.</li> <li>Close the dialog.</li> </ul>	 <p style="text-align: center;">PROFIsafe address in example project: 2</p>
26.	<p>Open the "Save basic functions (STO, SBC)" dialog.</p>	

## 6 Configuration and Settings

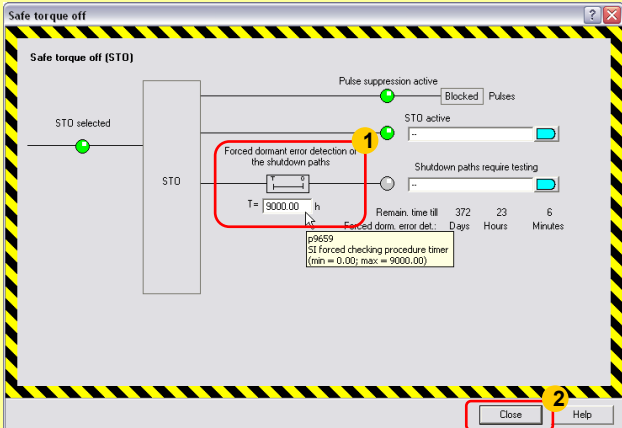
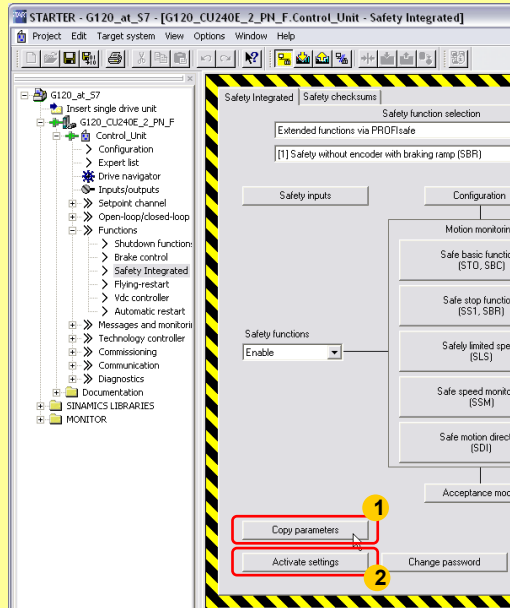
### 6.2 Configuration of the SINAMICS G120 drive via Ethernet

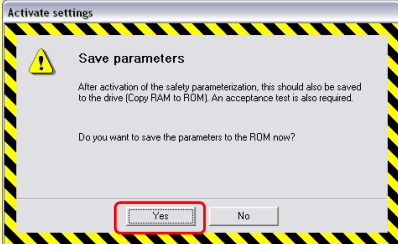
No.	Action	Remarks
27.	Disable the monitoring of the forced dormant error detection for the basic functions by setting the monitoring time to the maximum value (9000 hours). Close the dialog.	
28.	Click "Copy parameters" and then "Activate settings".	
29.	Specify a password. Then click "Activate settings" again.  (The password used in this example is "12345").	
30.	Choose "Yes", to save the parameters in ROM.	
31.	Briefly interrupt the supply voltage of the control unit.	Thus the CU transfers the parameters via a reboot.

## 6 Configuration and Settings

### 6.2 Configuration of the SINAMICS G120 drive via Ethernet

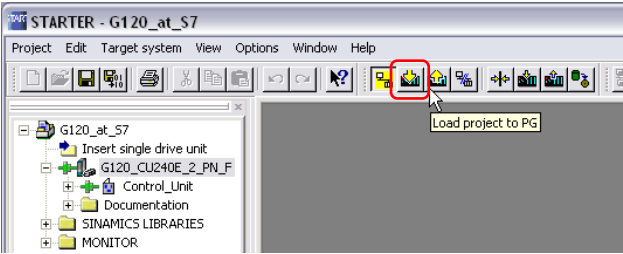
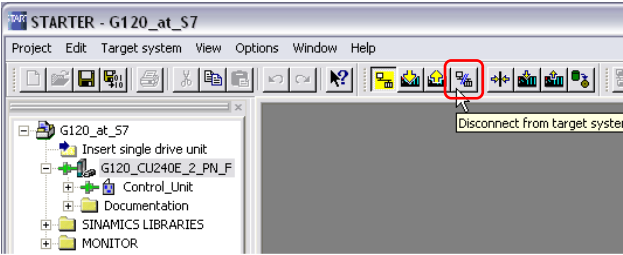
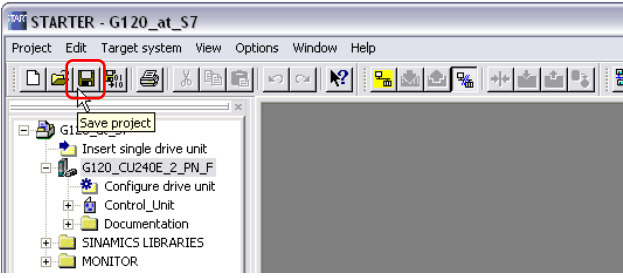
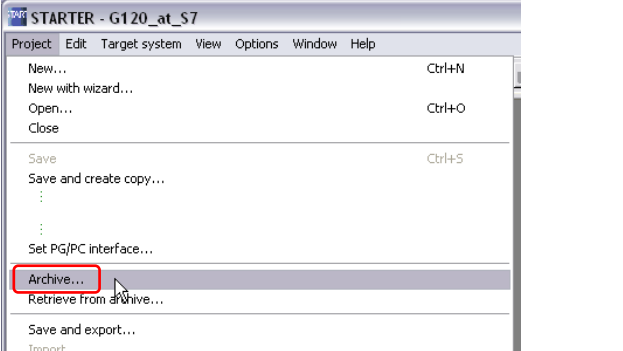
No.	Action	Remarks
32.	Download the configuration created online into the PG.	 <p>The screenshot shows the SIMATIC Manager interface for project 'STARTER - G120_at_S7'. The toolbar contains various icons, and the 'Load project to PG' icon (a yellow square with a blue 'L') is highlighted with a red box. A tooltip 'Load project to PG' is visible over the icon. The project tree on the left shows a hierarchy: G120_at_S7, Insert single drive unit, G120_CU240E_2_PN_F, Control_Unit, Documentation, SINAMICS LIBRARIES, and MONITOR.</p>
33.	Go offline.	 <p>The screenshot shows the SIMATIC Manager interface. The 'Disconnect from target system' icon (a blue square with a white 'D') in the toolbar is highlighted with a red box. A tooltip 'Disconnect from target system' is visible over the icon. The project tree on the left is the same as in the previous screenshot.</p>
34.	Save the project on your hard disc.	 <p>The screenshot shows the SIMATIC Manager interface. The 'Save project' icon (a yellow square with a blue 'S') in the toolbar is highlighted with a red box. A tooltip 'Save project' is visible over the icon. The project tree on the left shows an additional item: 'Configure drive unit'.</p>
35.	Archive the project.	 <p>The screenshot shows the 'File' menu in SIMATIC Manager. The 'Archive...' option is highlighted with a red box. Other menu items include 'New...', 'New with wizard...', 'Open...', 'Close', 'Save', 'Save and create copy...', 'Set PG/PC interface...', 'Retrieve from archive...', 'Save and export...', and 'Import...'.</p>





## 6.3 Configuring the SINAMICS G120 drive via USB

## 6.3 Configuring the SINAMICS G120 drive via USB

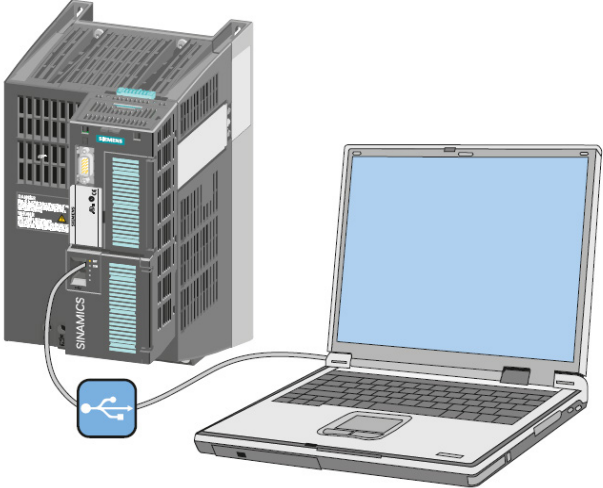

You can also configure the SINAMICS G120 via USB (PROFIBUS or PROFINET) rather than via field bus.

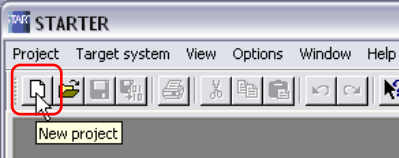
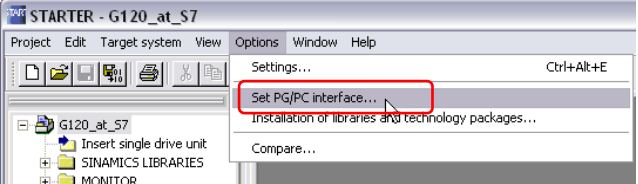
Table 6-3: Instruction drive configuration via USB

No.	Action	Remarks
1.	Connect the CU 240E-2 PN(-F) of SINAMICS G120 with the PG/PC using a USB cable.	
2.	Start the STARTER commissioning software.	
3.	Create a new project	
4.	Open "Set PG/PC interface".	

## 6 Configuration and Settings

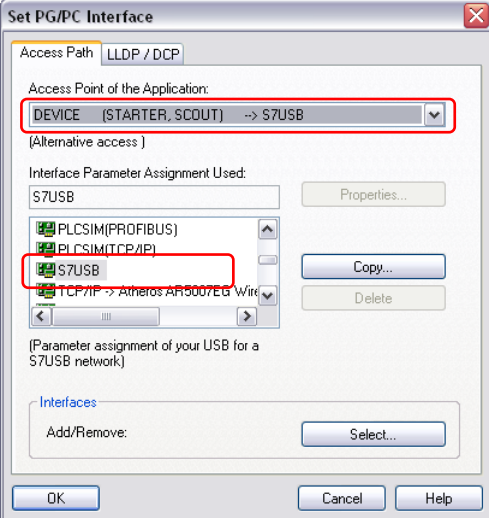
### 6.3 Configuring the SINAMICS G120 drive via USB

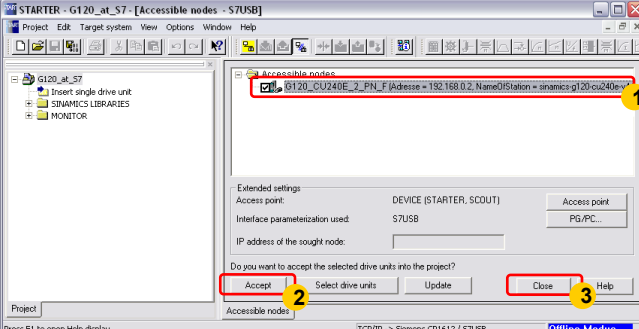
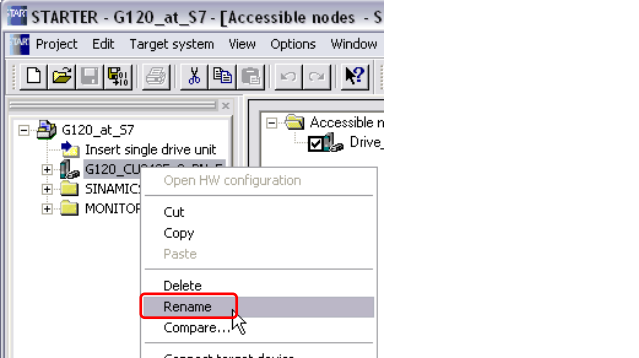
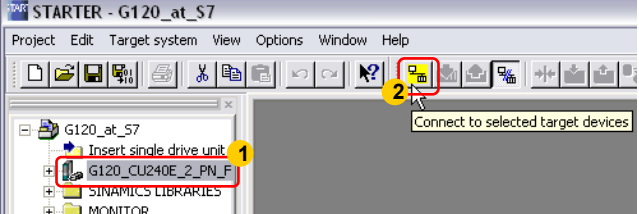
No.	Action	Remarks
5.	Select "DEVICE (STARTER, SCOUT)" as access point and "S7USB" as interface parameter assignment used.	
6.	Click on "Accessible nodes".	
7.	Tick the detected converter and click "Accept" to transfer the drive unit into the project.	
8.	Change the name of the drive unit according to your wishes. Right click the drive unit and select "Rename" in the context menu.	
9.	Select the converter in the tree and go online.	

## 6 Configuration and Settings

### 6.3 Configuring the SINAMICS G120 drive via USB

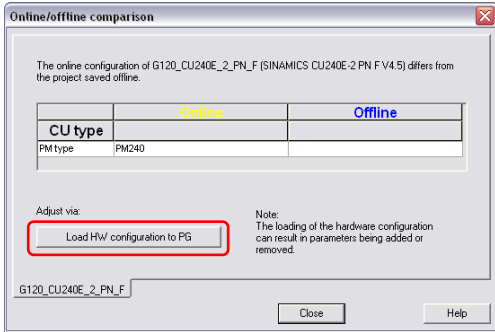
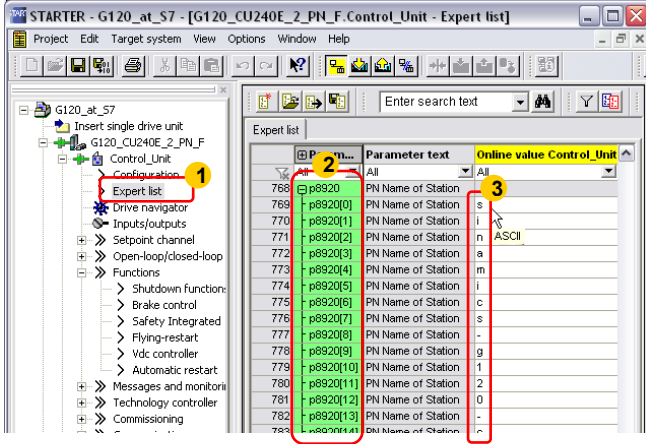
No.	Action	Remarks
10.	Download the hardware configuration into the PG/PC.	
11.	Now execute the steps 14 to 27 already explained in Table 6-2.	<ul style="list-style-type: none"> <li>Resetting the drive to factory settings.</li> <li>Configuring the drive via the wizard</li> <li>Specifying the data to be transferred (Siemens Tel. 352)</li> <li>Configuring safety functions</li> <li>Copying RAM to ROM</li> </ul>
12.	Assign the PROFINET device name to the IO device (drive) that is used in the network configuration of the CPU. For this purpose, go to the expert list of the control unit and enter the PROFINET name in parameter 8920 (PN Name of Station).	
13.	Proceed with the steps 28 to 32 in Table 6-2.	<ul style="list-style-type: none"> <li>Forcing new CU reboot</li> <li>Loading configuration to PG/PC</li> <li>Going offline</li> <li>Saving project on hard disk</li> <li>Archiving the project</li> </ul>

## 7 Related literature

Table 7-1

	Topic	Title / Link
\1\	Siemens Industry Online Support	<a href="http://support.automation.siemens.com">http://support.automation.siemens.com</a>
\2\	Download page of this entry	<a href="http://support.automation.siemens.com/WW/view/en/61450312">http://support.automation.siemens.com/WW/view/en/61450312</a>
\3\	STARTER	<a href="http://support.automation.siemens.com/WW/view/en/26233208">http://support.automation.siemens.com/WW/view/en/26233208</a>
\4\	GSDML files for SINAMICS G120	<a href="http://support.automation.siemens.com/WW/view/en/26641490">http://support.automation.siemens.com/WW/view/en/26641490</a>
\5\	SINAMICS G120 Manuals	Operating instructions CU240x-2: <a href="http://support.automation.siemens.com/WW/view/en/71762451">http://support.automation.siemens.com/WW/view/en/71762451</a> List manual CU240x-2 (parameters and error list): <a href="http://support.automation.siemens.com/WW/view/en/70983838">http://support.automation.siemens.com/WW/view/en/70983838</a> Function manual Safety Integrated: <a href="http://support.automation.siemens.com/WW/view/en/70235827">http://support.automation.siemens.com/WW/view/en/70235827</a>
\6\	Distributed Safety Handbuch	SIMATIC Safety – Configuring and Programming <a href="http://support.automation.siemens.com/WW/view/en/54110126">http://support.automation.siemens.com/WW/view/en/54110126</a>

## 8 History

Table 8-1

Version	Date	Modifications
V1.0	06/2012	First version
V1.1	08/2014	FB11 and FB12: Standardization connectors changed and initialization of the TEMP tag <b>InData</b> added