

GSC1系列交流接触器

GSC1 Series AC Contactor

——控制电器产品名录 2014

安全 智能 灵动

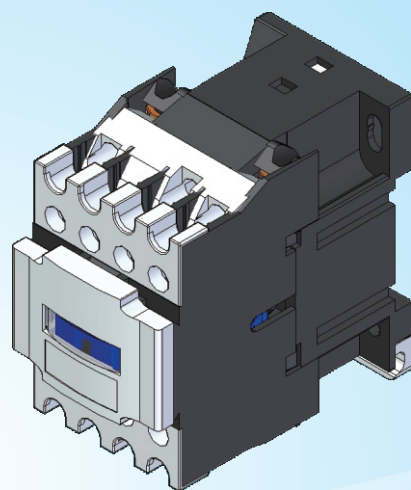

CE UL CCC TÜV CB RoHS

ISO9001 ISO14001 OHSAS18001

用途 APPLICATION

GSC1系列交流接触器主要用于交流50Hz(或60Hz),9A-95A额定绝缘电压为690V,115A-150A额定绝缘电压为1000V,在AC-3使用类别下额定工作电压为380V时额定工作电流至150A的电路中,供远距离接通和分断电路,并可与适当的热过载继电器组成电磁起动器以保护可能发生负荷的电路。

GSC1 series AC contactor is used in frequency 50Hz(or 60Hz), rated insulation voltage is up to 690V, 9A-95A rated isolation voltage up to 690V, 115A-150A rated isolation voltage up to 1000V, and rated current 150A under rated voltage 380V and category AC-3 circuit, for long-distance making and breaking circuit, and can interoperable with appropriate thermal overload relay as electromagnetic starter to protect potential overload circuit.

型号及含义 TYPE AND MEANING

△ GSC1-09~95

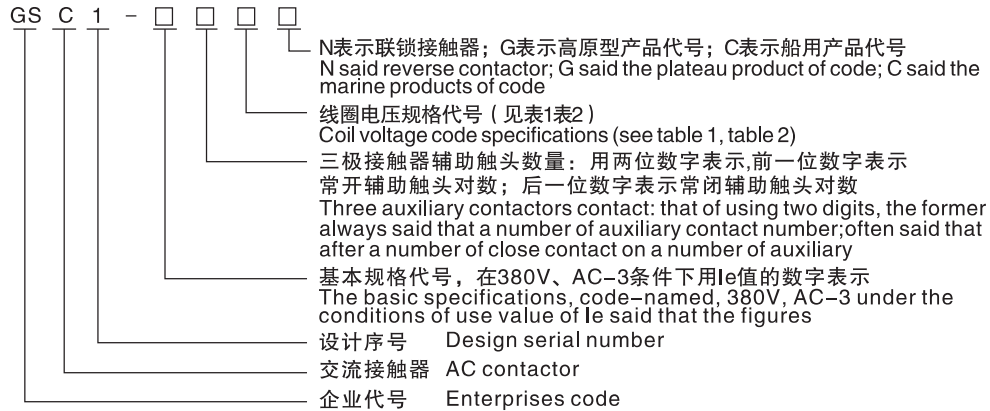

△ GSC1-115/150

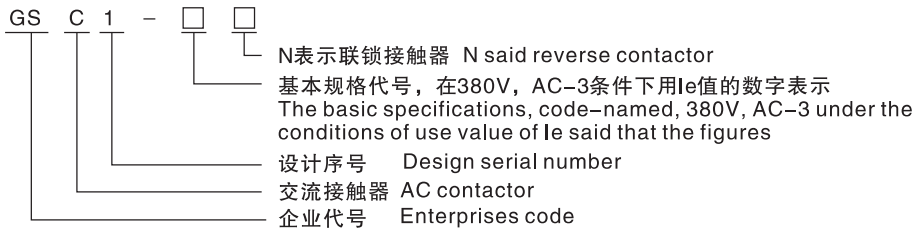

表(table)1

型号 type	电源频率Hz Power frequency	线圈电压V coil voltage					
		24	48	110~120	220~240	380	415
GSC1-09~38	50/60	B7	E7	F7	M7	/	/
	50	/	/	/	/	Q	/
	60	/	/	/	/	/	Q

表(table)2

型号 type	电源频率Hz Power frequency	线圈电压V coil voltage							
		24	48	110	120	220	240	380	415
GSC1-40~95	50/60	B7	E7	F7	/	M7	/	Q7	/
	50	B	E	F	/	M	/	Q	/
GSC1-115/150	60	/	/	/	F	/	M	/	Q
	50/60	B7	E7	F7	/	M7	/	Q7	/

结构特点 STRUCTURE FEATURE

- △ 动作机构为直动式,触头为双断点;
Direction-moving, double breaking contact terminals;
- △ 组合功能,除安装面外,其余各面均能加装附件;
Combination function, in addition to the installation surface, other surfaces can be added accessory;
- △ 两侧可加装辅助触头组(F3-d1)或联锁机构;

- Both sides can be fixed auxiliary contact arrangement (F3-d1) or reverse device;
- △ 上方可加装辅助触头组 (F3-d或F3-d2) 或空气延时头 (SK4-2/3d) ;
Can add installation auxiliary contact arrangement(F3-d or F3-d2) or air time-delay (SK4-2/3d) on above;
 - △ 线圈接线端可加装过电压抑制器等功能模块。
Wiring terminal can be added overvoltage suppressors and other function model.

工作条件和安装条件 WORKING CONDITION AND INSTALLATION CONDITION

- △ 周围空气温度-25℃ ~ +60℃;
Ambient temperature: -25℃ ~ +60℃;
- △ 安装地点海拔不超过3000m; Elevation≤3000m;
- △ 最高温度为+40℃时, 空气的相对湿度为不超过85%, 对由于温度变化偶尔产生的凝露应采取特殊的措施;
Relative humidity is not exceeding 85% at the maximum ambient temperature +40℃. Should give consideration to the dews, which would appear due to temperature change;
- △ 污染等级为“污染等级3”; Pollution grade: Grade 3;
- △ 安装类别为“安装类别Ⅲ”; Installation categories: class Ⅲ;
- △ 除用螺钉安装外, 还可采用35mm、75 mm标准卡轨安装。
Installation way: mounted by screw or 35mm、75mm standard rail track.
- △ 船用交流接触器: Marine AC contactor:
周围空气温度-25℃ ~ +60℃; Ambient temperature: -25℃ ~ +60℃;
- △ 大气条件: 可有凝露、盐雾、油雾、霉菌、海上潮湿空气等存在;
Air condition: be able to bear the influence of moisture in the air、salt fog、oil fog、mould、humid air on the sea;
- △ 各方向倾斜不大于22.5°, 各方向摇摆不大于22.5°, 周期10秒;
The tilt and swing gradient≤22.5°, bear time≤10s;
- △ 振动: 可安装和使用在频率2-13.2Hz, 振幅为±1mm以内, 又可使用在频率13.2~100Hz, 加速度为±7m/s² 以内的地方。
Shock: can bear frequency 2-13.2Hz and amplitude in ±1mm or frequency 13.2~100Hz and acceleration ±7m/s².

规格 CHARACTER

■ 接触器规格 contactor character

△ GSC1-09~95

表(table)3

型号 type	额定工作电流A AC-3 380V	控制功率kw control power					触头数量 Contact volume
		220V	380V	415V	440V	660V	
GSC1-09	9	2.2	4	4	4	5.5	3P+1NO或 3P+1NC
GSC1-12	12	3	5.5	5.5	5.5	7.5	
GSC1-18	18	4	7.5	9	9	9	
GSC1-25	25	5.5	11	11	11	15	
GSC1-32	32	7.5	15	15	15	18.5	
GSC1-38	38	9	18.5	18.5	18.5	18.5	
GSC1-40	40	11	18.5	22	22	30	3P+1NO+1NC
GSC1-50	50	15	22	25	30	33	
GSC1-65	65	18.5	30	37	37	37	
GSC1-80	80	22	37	45	45	45	
GSC1-95	95	25	45	45	45	45	

△ GSC1-115/150

表(table)4

型号 type	额定发热电流 I _{th} (A) Conventional thermal current	AC-3使用类别 using type				触头 数量 Contact volume
		额定工作电流 I _e (A) Tated working current		控制三相鼠笼型电动机最大功率 (KW) Control 3 phase squirrel cage motor maximum power		
		380V	660V	380V	660V	
GSC1-115	200	115	86	55	80	3P
GSC1-150	200	150	107	75	100	

3P: 三对常开主触头 NO: 一对常开辅助触头 NC: 一对常闭辅助触头

3P: three pair normal open main contact; NO: one pair normal open auxiliary contact; NC: one pair normal close auxiliary contact

■ 附件规格 Annex character

△ F3-d辅助触头组 Auxiliary contact team

表(table)5

型号 type	触头数量 Contact volume	挂接方式 Install way
F3-10d2	1NO	装在GSC1-25-95顶部 Install on GSC1-25-95 top
F3-01d2	1NC	
F3-20d1	2NO	装在GSC1-09-95的侧面 Install on GSC1-09-95 side
F3-11d1	1NO+1NC	
F3-20d	2NO	装在GSC1-09-150的顶部 Install on GSC1-09-150 top
F3-11d	1NO+1NC	
F3-02d	2NC	
F3-22d	2NO+2NC	
F3-40d	4NO	
F3-04d	4NC	
F3-31d	3NO+1NC	
F3-13d	1NO+3NC	

△ SK4-d空气延时头 SK4-d Air time-delay

表(table)6

型号 type	延时范围 time-delay area	延时方式 time-delay way	延时触头数量 Time-delay contact volume
Sk4-220d	0.1~3S	通电延时 Making time-delay	1NO+1NC
Sk4-222d	0.1~30S		
Sk4-224d	10~180S		
Sk4-320d	0.1~3S	断电延时 Breaking time-delay	
Sk4-322d	0.1~30S		
Sk4-324d	10~180S		

技术参数 TECHNICAL PARAMETERS

本系列产品符合标准: IEC60947-4, GB14048.4 The range product meet standard: IEC60947-4, GB14048.4

△ GSC1-9-95

型号 type		GSC1-09	GSC1-12	GSC1-18	GSC1-25	GSC1-32	GSC1-38	GSC1-40	GSC1-50	GSC1-65	GSC1-80	GSC1-95												
参数 parameters	额定工作电压 Rated voltage Ue V (AC-3)	380V	9	12	18	25	32	38	40	50	65	80	95											
	额定工作电压 Rated voltage Ue V (AC-3)	660V	6.6	8.9	12	18	21	21.5	34	39	42	49	49											
约定发热电流 Ith A Conventional thermal current			25	25	32	40	50	50	60	80	80	125	125											
额定工作电压 Ue V Rated work voltage			660 380				380	660 380																
额定绝缘电压 Ui V Rated insulation voltage			690																					
AC-3 (6le, le)	电寿命(10 ⁴ 次) Electric life span		100	100	100	100	80	50	80	60	60	60	60											
	操作频率 h ⁻¹ Operation frequency		1200	1200	1200	1200	600	600	600	600	600	600	600											
AC-4 (6le, 6le)	电寿命(10 ⁴ 次) Electric life span		20	20	20	20	20	15	15	15	15	10	10											
	操作频率 h ⁻¹ Operation frequency							300																
辅助触头 Auxiliary contact	约定发热电流 Ith A Conventional thermal current		10																					
	可接通最小负载 Connect minimum load		24V 10mA																					
线圈 Coil	额定控制电压 Us V Rated control voltage		24、48、110、220、380																					
	吸合电压 Pull voltage		0.85~1.10Us																					
线圈 Coil	释放电压 Release voltage		0.2~0.75 Us																					
	线圈功率 VA Coil power		76	76	76	110	110	110	230	230	230	230	230											
机械寿命 10 ⁴ 次 Machinery life span of trip times	吸合 pull		10	10	10	11	11	11	32	32	32	32	32											
	保持 contain		10	10	10	11	11	11	32	32	32	32	32											
机械寿命 10 ⁴ 次 Machinery life span of trip times			1000					800					600											
接线端子可接线 mm ² Terminal Blocks can wiring mm ²	导线根数 Wire a few root		1	2	1	2	1	2	1	2	1	2	1	2	1	2	1	2						
	软线 Soft Line		2.5	2.5	2.5	2.5	4	4	4	4	6	6	6	6	10	10	16	16	16	16	50	25	50	25
接线端子可接线 mm ² Terminal Blocks can wiring mm ²	硬线 Hard Line		4	4	4	4	6	6	6	-	10	10	10	10	10	10	25	-	25	-	50	-	50	-

△ GSC1-115/150

接触器型号 contactor type		GSC1-115				GSC1-150			
额定工作电流 Ie A (AC-3) Rated working current	380 V	115				150			
	660 V	86				107			
约定发热电流 Ith (A) conventional thermal current		200							
额定工作电压 Ue (V) Rated working voltage		380、660							
额定绝缘电压 Ui (V) Rated insulation voltage		1000							
AC-3 (6le, le)	电寿命 10 ⁴ 次 Life span of trip 10 ⁴ time	40				40			
	操作频率 h ⁻¹ Operatin frequency	600							

AC-4 (6le、6le)	电寿命 10^4 次 Life span of trip 10^4 time		10			
	操作频率 h^{-1} Operatin frequency		150			
	额定工作电流 I_e (A) Rated working current	380 V	52	60		
		660 V	25	38		
线圈参数 Coil character	额定控制电压 U_s (V) Rated control voltage		24 V、36 V、48 V、110 V、200 V、220V、380 V			
	吸合电压 pull voltage		0.85 U_s ~ 1.1 U_s			
	释放电压 release		0.2 U_s ~ 0.55 U_s			
	吸合功率 (VA) pull power		300			
	保持功率 (VA) contain power		22			
机械寿命 10^4 次 Machinery life span of trip times		200				
接线端子可 接线 mm^2 Terminal Blocks can wiring mm^2	导线根数 Wire a few root	1	2	1	2	
	导线(mm^2) Wire(mm^2)	95	/	120	/	
	导电片 (尺寸 mm)	/	20×3	/	25×3	

外形尺寸与安装尺寸 OUTLINE DIMENSIONS AND MOUNTING DIMENSIONS

△ GSC1-09/12/18

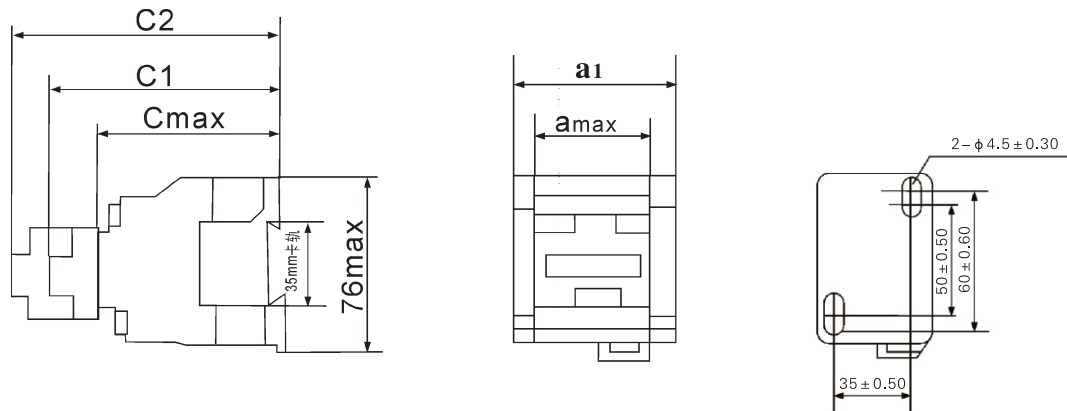

注(remark): C: GSC1 C1: GSC1+F3-d C2: GSC1+SK4-2/3d a1: GSC1+2 (F3-d1)

型号 type	amax	Cmax	C1	C2	a1
GSC1-09/12	47	84	115	134	73
GSC1-18	47	87	120	139	73

△ GSC1-09/12/18 +JRS4-09d/25d 、 GSC1-09/12/18 +GSR3-09/25

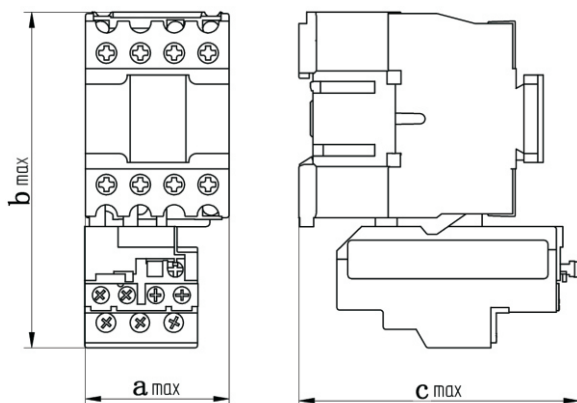

接触器+热继电器型号	amax	bmax	cmax
GSC1-09/12/18+JRS4-09d/25d	47	123	98
GSC1-09/12/18 +GSR3-09/25	47	128	98

△ GSC1-25/32/38

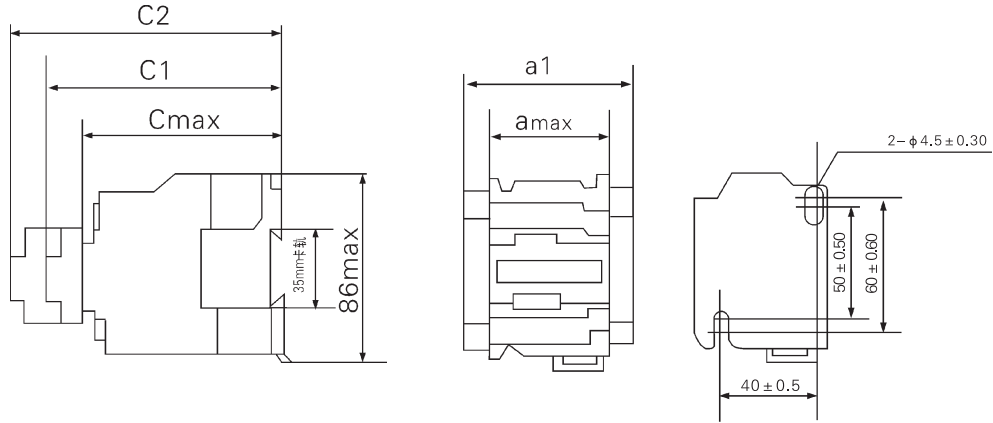

注(remark):

C: GSC1

C1: GSC1+F3-d (或F3-d2)

C2: GSC1+SK4-2/3d

a1: GSC1+2 (F3-d1)

型号type	amax	cmax	C1	C2	a1
GSC1-25	59	97	130	149	85
GSC1-32	59	102	135	154	85
GSC1-38	59	102	135	154	85

△ GSC1-25/32/38+JRS4-09d/25d, GSC1-25/32/38+GSR3-09/25, GSC1-32/38+JRS4-32d

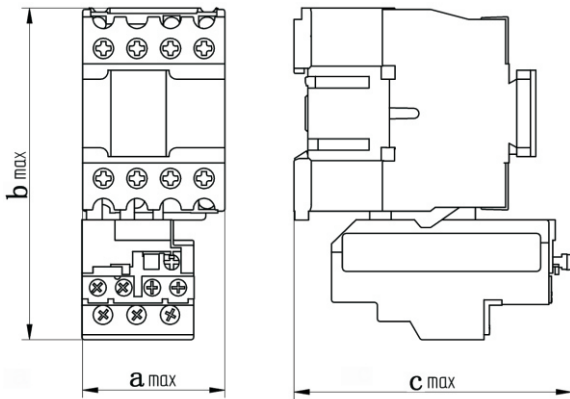

型号Type	amax	bmax	cmax
GSC1-25/32/38+JRS4-09d/25d	59	132	110
GSC1-25/32/38+GSR3-09/25	59	137	105
GSC1-32/38+JRS4-32d	59	142	102

△ GSC1-40/50/65/80/95

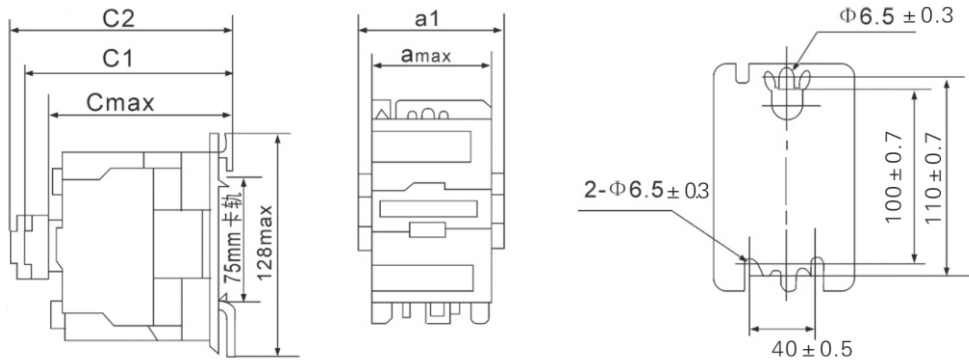

注(remark) :

C: GSC1

C1: GSC1+F3-d (或F3-d2)

C2: GSC1+SK4-2/3d

a1: GSC1+2 (F3-d1)

型号type	amax	cmax	C1	C2	a1
GSC1-40d/50d/65d	79	118	149	168	105
GSC1-80d/95d	87	127	160	179	113

△ GSC1-40/50/65/80/95+JRS4-40/80d

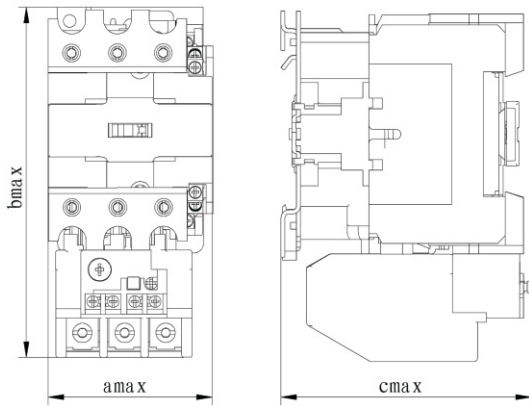

产品型号 Product Type	amax	bmax	cmax
GSC1-40/50/65+JRS4-40d/80d	79	178	128
GSC1-80/95+JRS4-40d/80d	87	181	132

△ GSC1-40/50/65/80/95+GSR3-40/95

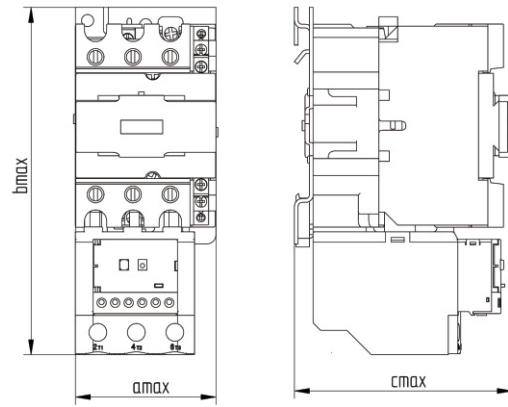

产品型号 Product Type	amax	bmax	cmax
GSC1-40/50/65+GSR3-40/95	79	188	118
GSC1-80/95+GSR3-40/95	87	191	127

△ GSC1-115/150

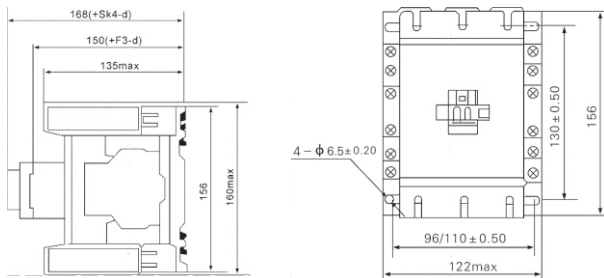

△ GSC1-115/150+JRS4-140d

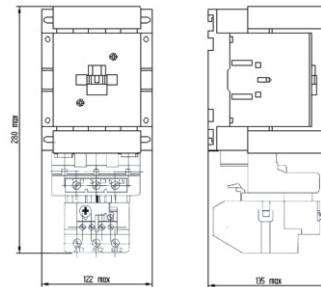

接线图 WIRING PICTURE

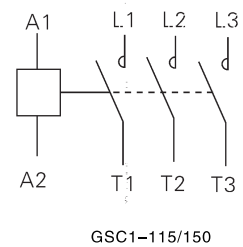
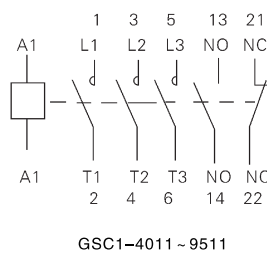
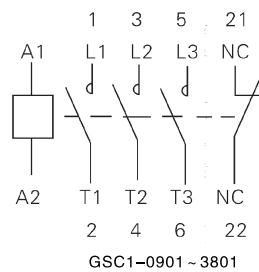
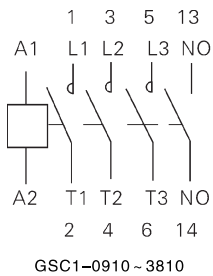

订货须知 ORDER REMARK

■ 在订货中应写明以下内容： In order need attention following:

- △ 接触器的全型号及名称； Entitle type of contactor;
- △ 控制线圈的频率及电压； Frequency and Voltage of control coil;
- △ 订购数量： Order volume:

例如：交流接触器 GSC1-0910 M7 220V~240V 50Hz/60Hz 10台

Example: AC contactor GSC1-0910 M7 220V~240V 50Hz/60Hz 10 sets

表示为9A接触器，辅助触头为常开，控制电压的频率为50Hz/60Hz，电压为220V~240V，订货数量为10台。

Means need: the contactor is 9A, normal open auxiliary, control voltage frequency 50Hz/60Hz, voltage 220V~240V, volume 10 sets.

- △ 特殊电压规格产品,如用户需要可特殊订货。

Special voltage character product, can special customize if need.