

共同规格

| | | | | | | | |
|----------|---|-----|-----|----|----|-----|------------|
| 缸径(mm) | 32 | 40 | 50 | 63 | 80 | 100 | 125 |
| 动作方式 | 双作用 | | | | | | |
| 使用流体 | 空气 | | | | | | |
| 最高使用压力 | 1.0MPa | | | | | | |
| 最低使用压力 | 0.05MPa | | | | | | |
| 环境和流体温度 | 无内置磁环:-10~70°C (未冻结) 内置磁环:-10~60°C (未冻结) | | | | | | |
| * 润滑 | 不需要 | | | | | | |
| 活塞速度 | 50~1000mm/s | | | | | | 50~700mm/s |
| 行程公差(mm) | -250: ^{+1.0} ₀ , 251~1000: ^{+1.4} ₀ , 1001~1500: ^{+1.8} ₀ | | | | | | |
| 缓冲 | 气缓冲 | | | | | | |
| 接管口径(Rc) | 1/8 | 1/4 | 3/8 | | | | 1/2 |

* 如需要润滑, 请用透平1号油ISO VG32。

型号表示方法

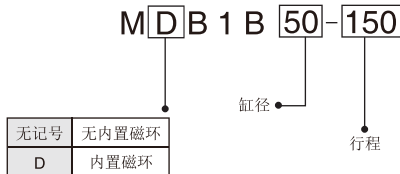

订货举例

- 所需缸径: 32, 行程: 250,
正确型号: MB1B32-250
- 所需缸径: 63, 行程: 600, 需磁性开关, 脚座安装型
正确型号: MDB1B63-600
1个气缸
MB-L06
D-M9BL
2个磁性开关
BMP1-032
2个磁性开关安装码
BMG2-012

磁性开关最小安装行程表

| 磁性开关 | 安装数量 | ø32 | ø40 | ø50 | ø63 | ø80 | ø100 | ø125 |
|-------------------|--------------|------------|-----|------------|------------|-----|------------|------|
| D-A9□L D-A9□VL | 2 (不同/同一安装面) | 15 | | | | | | |
| | 1 | 15 | | | 10 | | | |
| | n | 15+10(n-2) | | 15+15(n-2) | | | 15+20(n-2) | |
| D-M9□L D-M9□VL | 2 (不同/同一安装面) | 15 | | | 10 | | | |
| | 1 | 15 | | | 10 | | | |
| | n | 15+5(n-2) | | | 10+10(n-2) | | | |

注: n = 3, 4, 5... (n = 磁性开关安装数量)

行程/磁性开关型号表

| 缸径 (mm) | 标准行程(mm) | 磁性开关 | | | 磁性开关 安装码 | 密封包型号 双作用 |
|------------|--|-----------|-----------|-----------|---------------------------|--------------|
| | | 有触点 | 无触点 | | | |
| | | 2线 | 2线 | 3线NPN | | |
| 32 | 25, 50, 75, 100, 125, 150, 175, 200, 250, 300, 350, 400, 450, 500 | D-A93(V)L | D-M9B(V)L | D-M9N(V)L | BMP1-032 + BMG2-012 | MB32-PS |
| | | | | | | MB40-PS |
| MB50-PS | | | | | | |
| MB63-PS | | | | | | |
| MB80-PS | | | | | | |
| MB100-PS | | | | | | |
| MB125-PS | | | | | | |

外形尺寸图 (毫米)

基本型

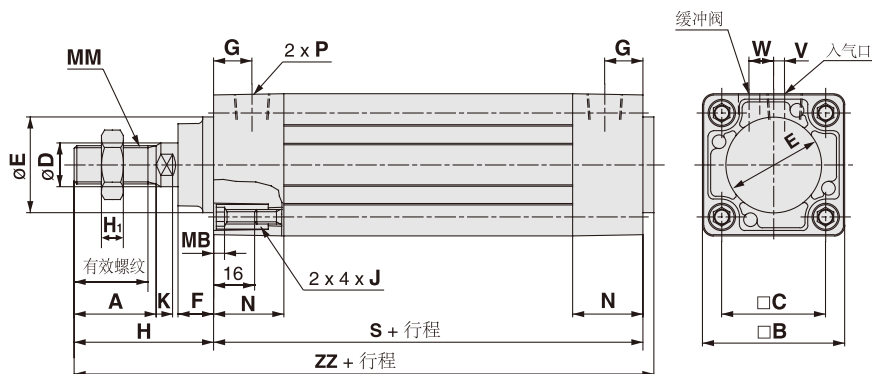

| 缸径 (mm) | 有效的 螺纹长度 | 二面 宽 | A | B | C | D | Ee11 | F | G | H ₁ | H | MA | MB | J | K | MM | N | P | S | V | W | ZZ |
|------------|-------------|---------|----|-----|------|----|------|----|------|----------------|----|----|----|------------|----|------------|------|-----|-----|------|------|-----|
| 32 | 19.5 | 10 | 22 | 46 | 32.5 | 12 | 30 | 13 | 13 | 6 | 47 | 16 | 4 | M6 x 1 | 6 | M10 x 1.25 | 27 | 1/8 | 84 | 4 | 6.5 | 135 |
| 40 | 27 | 14 | 30 | 52 | 38 | 16 | 35 | 13 | 14 | 8 | 51 | 16 | 4 | M6 x 1 | 6 | M14 x 1.5 | 27 | 1/4 | 84 | 4 | 9 | 139 |
| 50 | 32 | 18 | 35 | 65 | 46.5 | 20 | 40 | 14 | 15.5 | 11 | 58 | 16 | 5 | M8 x 1.25 | 7 | M18 x 1.5 | 31.5 | 1/4 | 94 | 5 | 10.5 | 156 |
| 63 | 32 | 18 | 35 | 75 | 56.5 | 20 | 45 | 14 | 16.5 | 11 | 58 | 16 | 5 | M8 x 1.25 | 7 | M18 x 1.5 | 31.5 | 3/8 | 94 | 9 | 12 | 156 |
| 80 | 37 | 22 | 40 | 95 | 72 | 25 | 45 | 20 | 19 | 13 | 72 | 16 | 5 | M10 x 1.5 | 10 | M22 x 1.5 | 38 | 3/8 | 114 | 11.5 | 14 | 190 |
| 100 | 37 | 26 | 40 | 114 | 89 | 30 | 55 | 20 | 19 | 16 | 72 | 16 | 5 | M10 x 1.5 | 10 | M26 x 1.5 | 38 | 1/2 | 114 | 17 | 15 | 190 |
| 125 | 50 | 27 | 54 | 136 | 110 | 32 | 60 | 27 | 19 | 16 | 97 | 20 | 6 | M12 x 1.75 | 13 | M27 x 2 | 38 | 1/2 | 120 | 17 | 15 | 223 |

正方形缸体气缸：MB1系列

外形尺寸图 (毫米)

脚座型

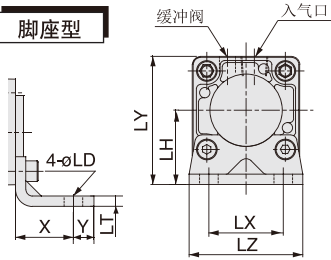

| 缸径 (mm) | 零件号* | X | Y | LD | LH | LT | LX | LY | LZ |
|---------|--------|----|----|----|----|-----|----|-------|-----|
| 32 | MB-L03 | 22 | 9 | 7 | 30 | 3.2 | 32 | 53 | 50 |
| 40 | MB-L04 | 24 | 11 | 9 | 33 | 3.2 | 38 | 59 | 55 |
| 50 | MB-L05 | 27 | 11 | 9 | 40 | 3.2 | 46 | 72.5 | 70 |
| 63 | MB-L06 | 27 | 14 | 12 | 45 | 3.6 | 56 | 82.5 | 80 |
| 80 | MB-L08 | 30 | 14 | 12 | 55 | 4.5 | 72 | 102.5 | 100 |
| 100 | MB-L10 | 32 | 16 | 14 | 65 | 4.5 | 89 | 122 | 120 |
| 125 | MB-L12 | 45 | 20 | 14 | 81 | 8 | 90 | 149 | 136 |

*订购脚座时，需订2pcs

法兰型

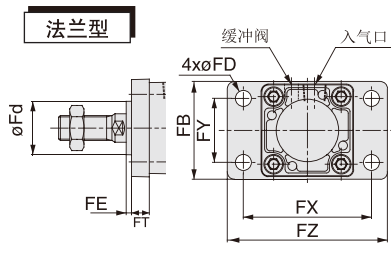

| 缸径 (mm) | 零件号 | FB | FD | FE | FT | FX | FY | FZ | Fd |
|---------|--------|-----|----|----|----|-----|-----|-----|------|
| 32 | MB-F03 | 50 | 7 | 3 | 10 | 64 | 32 | 79 | 25 |
| 40 | MB-F04 | 55 | 9 | 3 | 10 | 72 | 36 | 90 | 31 |
| 50 | MB-F05 | 70 | 9 | 2 | 12 | 90 | 45 | 110 | 38.5 |
| 63 | MB-F06 | 80 | 9 | 2 | 12 | 100 | 50 | 120 | 39.5 |
| 80 | MB-F08 | 100 | 12 | 4 | 16 | 126 | 63 | 153 | 45.5 |
| 100 | MB-F10 | 120 | 14 | 4 | 16 | 150 | 75 | 178 | 54 |
| 125 | MB-F12 | 138 | 14 | 7 | 20 | 180 | 102 | 216 | 57.5 |

单耳环

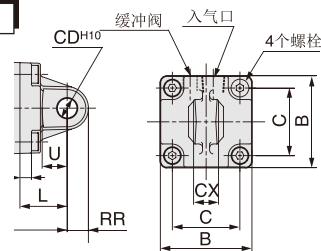

| 缸径 (mm) | 零件号 | B | C | JN | L | RR | U | CD ^{H10} | CX ^{±0.3} |
|---------|--------|-----|------|----|----|------|----|-------------------|--------------------|
| 32 | MB-C03 | 46 | 32.5 | 5 | 23 | 10.5 | 13 | 10 | 14 |
| 40 | MB-C04 | 52 | 38 | 5 | 23 | 11 | 13 | 10 | 14 |
| 50 | MB-C05 | 65 | 46.5 | 6 | 30 | 15 | 17 | 14 | 20 |
| 63 | MB-C06 | 75 | 56.5 | 6 | 30 | 15 | 17 | 14 | 20 |
| 80 | MB-C08 | 95 | 72 | 8 | 42 | 23 | 26 | 22 | 30 |
| 100 | MB-C10 | 114 | 89 | 8 | 42 | 23 | 26 | 22 | 30 |
| 125 | MB-C12 | 136 | 110 | 10 | 50 | 28 | 30 | 25 | 32 |

双耳环

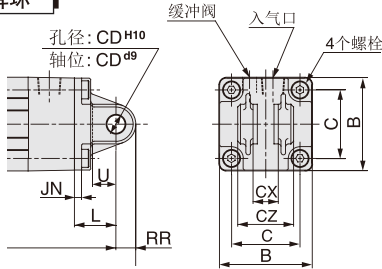

| 缸径 (mm) | 零件号 | B | C | JN | L | RR | U | CD ^{H10} | CX ^{±0.3} | CZ |
|---------|--------|-----|------|----|----|------|----|-------------------|--------------------|----|
| 32 | MB-D03 | 46 | 32.5 | 5 | 23 | 10.5 | 13 | 10 | 14 | 28 |
| 40 | MB-D04 | 52 | 38 | 5 | 23 | 11 | 13 | 10 | 14 | 28 |
| 50 | MB-D05 | 65 | 46.5 | 6 | 30 | 15 | 17 | 14 | 20 | 40 |
| 63 | MB-D06 | 75 | 56.5 | 6 | 30 | 15 | 17 | 14 | 20 | 40 |
| 80 | MB-D08 | 95 | 72 | 8 | 42 | 23 | 26 | 22 | 30 | 60 |
| 100 | MB-D10 | 114 | 89 | 8 | 42 | 23 | 26 | 22 | 30 | 60 |
| 125 | MB-D12 | 136 | 110 | 10 | 50 | 28 | 30 | 25 | 32 | 64 |

双耳轴座

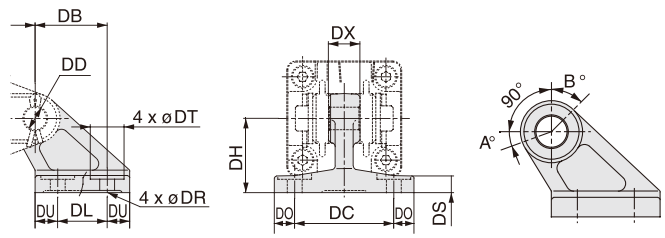

| 缸径 (mm) | 零件号 | DB | DL | DU | DC | DX | DO | DR | DT | DS | DH | DD ^{H10} | A° | B° | A°+B°+90° |
|---------|--------|----|----|------|-----|----|------|------|----|----|----|-----------------------------------|-----|-----|-----------|
| 32 | MB-B03 | 32 | 22 | 10 | 44 | 14 | 9 | 6.6 | 15 | 7 | 33 | 10 ^{+0.058} ₀ | 25° | 45° | 160° |
| 40 | | 32 | 22 | 10 | 44 | 14 | 9 | 6.6 | 15 | 7 | 33 | 10 ^{+0.058} ₀ | | | |
| 50 | MB-B05 | 43 | 30 | 11.5 | 60 | 20 | 10.5 | 9 | 18 | 8 | 45 | 14 ^{+0.070} ₀ | 40° | 60° | 190° |
| 63 | | 43 | 30 | 11.5 | 60 | 20 | 10.5 | 9 | 18 | 8 | 45 | 14 ^{+0.070} ₀ | | | |
| 80 | MB-B08 | 64 | 45 | 14 | 86 | 30 | 12.5 | 11 | 22 | 10 | 65 | 22 ^{+0.084} ₀ | 30° | 55° | 175° |
| 100 | | 64 | 45 | 14 | 86 | 30 | 12.5 | 11 | 22 | 10 | 65 | 22 ^{+0.084} ₀ | | | |
| 125 | MB-B12 | 78 | 60 | 15 | 110 | 32 | 13 | 13.5 | 24 | 14 | 75 | 25 ^{+0.084} ₀ | 30° | 50° | 170° |

活塞杆端螺母

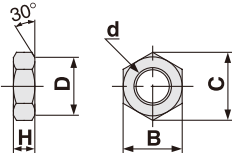

| 缸径 (mm) | 零件号 | d | H | B | C | D |
|---------|--------|------------|----|----|------|------|
| 32 | NT-03 | M10 x 1.25 | 6 | 17 | 19.6 | 16.5 |
| 40 | NT-04 | M14 x 1.5 | 8 | 22 | 25.4 | 21 |
| 50, 63 | NT-05 | M18 x 1.5 | 11 | 27 | 31.2 | 26 |
| 80 | NT-08 | M22 x 1.5 | 13 | 32 | 37.0 | 31 |
| 100 | NT-10 | M26 x 1.5 | 16 | 41 | 47.3 | 39 |
| 125 | NT-12M | M27 x 2 | 16 | 41 | 47.3 | 39 |

肘接头销/耳环销

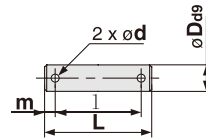

| 缸径 (mm) | 零件号 | D _{d9} | L | l | m | d |
|---------|--------|--|------|------|-----|---|
| 32, 40 | CD-M03 | 10 ^{-0.040} _{-0.078} | 44 | 36 | 4 | 3 |
| 50, 63 | CD-M05 | 14 ^{-0.050} _{-0.093} | 60 | 51 | 4.5 | 4 |
| 80, 100 | CD-M08 | 22 ^{-0.065} _{-0.117} | 82 | 72 | 5 | 4 |
| 125 | IY-12 | 25 ^{-0.065} _{-0.117} | 79.5 | 69.5 | 5 | 4 |

I型单肘接头

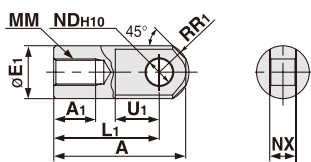

| 缸径 (mm) | 零件号 | A | A ₁ | E ₁ | L ₁ | MM | R ₁ | U ₁ | ND ^{H10} | NX |
|---------|-------|-----|----------------|----------------|----------------|------------|----------------|----------------|-------------------------------------|--------------------------------------|
| 32 | I-03M | 40 | 14 | 20 | 30 | M10 x 1.25 | 12 | 16 | 10 ^{+0.058} _{0.0} | 14 ^{-0.10} _{-0.30} |
| 40 | I-04M | 50 | 19 | 22 | 40 | M14 x 1.5 | 12.5 | 19 | 10 ^{+0.058} _{0.0} | 14 ^{-0.10} _{-0.30} |
| 50, 63 | I-05M | 64 | 24 | 28 | 50 | M18 x 1.5 | 16.5 | 24 | 14 ^{+0.070} _{0.0} | 20 ^{-0.10} _{-0.30} |
| 80 | I-08M | 80 | 26 | 40 | 60 | M22 x 1.5 | 23.5 | 34 | 22 ^{+0.084} _{0.0} | 30 ^{-0.10} _{-0.30} |
| 100 | I-10M | 80 | 26 | 40 | 60 | M26 x 1.5 | 23.5 | 34 | 22 ^{+0.084} _{0.0} | 30 ^{-0.10} _{-0.30} |
| 125 | I-12M | 119 | 36 | 46 | 92 | M27 x 2 | 28.5 | 34 | 25 ^{+0.084} _{0.0} | 32 ^{-0.10} _{-0.30} |

Y型单肘接头

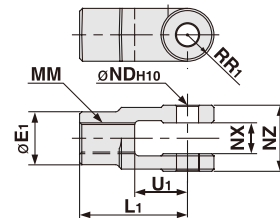

| 缸径 (mm) | 零件号 | E ₁ | L ₁ | MM | R ₁ | U ₁ | ND ^{H10} | NX | NZ |
|---------|-------|----------------|----------------|------------|----------------|----------------|-------------------------------------|--------------------------------------|--------------------------------------|
| 32 | Y-03M | 20 | 30 | M10 x 1.25 | 10 | 16 | 10 ^{+0.058} _{0.0} | 14 ^{+0.30} _{+0.10} | 28 ^{-0.10} _{-0.30} |
| 40 | Y-04M | 22 | 40 | M14 x 1.5 | 11 | 19 | 10 ^{+0.058} _{0.0} | 14 ^{+0.30} _{+0.10} | 28 ^{-0.10} _{-0.30} |
| 50, 63 | Y-05M | 28 | 50 | M18 x 1.5 | 14 | 24 | 14 ^{+0.070} _{0.0} | 20 ^{+0.30} _{+0.10} | 40 ^{-0.10} _{-0.30} |
| 80 | Y-08M | 40 | 65 | M22 x 1.5 | 20 | 34 | 22 ^{+0.084} _{0.0} | 30 ^{+0.10} _{+0.10} | 60 ^{-0.10} _{-0.30} |
| 100 | Y-10M | 40 | 65 | M26 x 1.5 | 20 | 34 | 22 ^{+0.084} _{0.0} | 30 ^{+0.30} _{+0.10} | 60 ^{-0.10} _{-0.30} |
| 125 | Y-12M | 46 | 100 | M27 x 2 | 27 | 42 | 25 ^{+0.084} _{0.0} | 32 ^{+0.30} _{+0.10} | 64 ^{-0.10} _{-0.30} |